

# The geometry of Arthur's truncation operator

by **Bill Casselman**

**This talk can be found at**

<http://www.math.ubc.ca/~cass/banff/banff-2021.pdf>

A certain truncation operator, first defined in 1965 in some form by Langlands and later generalized by Arthur, plays a crucial role in the theory of automorphic forms, particularly in the construction of Eisenstein series and in the trace formula.

For most of us this operator is, in Peter Sarnak's phrase, a black box. But I have been fascinated by it ever since I first encountered it—in fact, since a visit to Luminy mentioned by Patrick Delorme about 30 years ago. What puzzled me at first sight was the definition. (I was in good company. Jim Arthur tells me that Deligne, in Corvallis, also expressed surprise.) There are other puzzling features that become even more puzzling upon closer inspection. In this talk I shall point out some of these, and I shall also offer a few guesses about truncation operators, as well as mention some possible new applications.

I'll begin with a short history of early days. I'll continue with a discussion of partitions of arithmetic quotients found originally by Langlands, although implicit in the construction of compactifications of arithmetic quotients by Satake. I'll discuss what I believe to be an optimal one. Then I'll show how this relates to truncation.

Some of what I'll say is known only for a few groups, including  $GL_n$  and  $SL_n$ , but will probably remain true in some suitable formulation for all rational reductive groups.

When I started to prepare this talk, I hoped to verify a few ideas about truncation that I have had in mind for a long time. Some of the most interesting ones turned out to be false! To replace them I have come up with new proposals that I have not had time to probe carefully. In other words:



*This is a report on work in progress.*

One of my ultimate goals is to find a new construction of Eisenstein series, resulting eventually in a stronger version of analysis on certain spaces of functions on arithmetic quotients. I hope this will eventually lead to a way of approaching the trace formula hinted at by some work of Sakellaridis.

## Contents

1. History .....	5
1.1. $SL(2)$ .....	5
1.2. Groups of higher rank .....	12
2. Notation .....	16
3. Toy models .....	19
4. Partition .....	25
5. Truncation .....	36
5.1. Crude truncation .....	36
5.2. Arthur's truncation .....	39
5.3. Questions .....	42
6. References .....	44
6.1. Partition .....	44
6.2. Truncation .....	45
6.3. Eisenstein series .....	46

## 1. History

**1.1.  $SL(2)$**  The story of truncation operators begins with a well known paper by Hans Maaß about real analytic automorphic forms for

$$\Gamma = SL_2(\mathbb{Z}).$$

He used a kind of truncation of Eisenstein series to verify an estimate of the dimension of certain spaces.

The version we use today was stated by Selberg, exactly as we do now, in his 1962 ICM talk.

The group  $\Gamma$  acts by linear fractional transformations on the upper half plane  $\mathcal{H}$ . Fundamental domains for both  $\Gamma \cap P$  and  $\Gamma$  are well known:

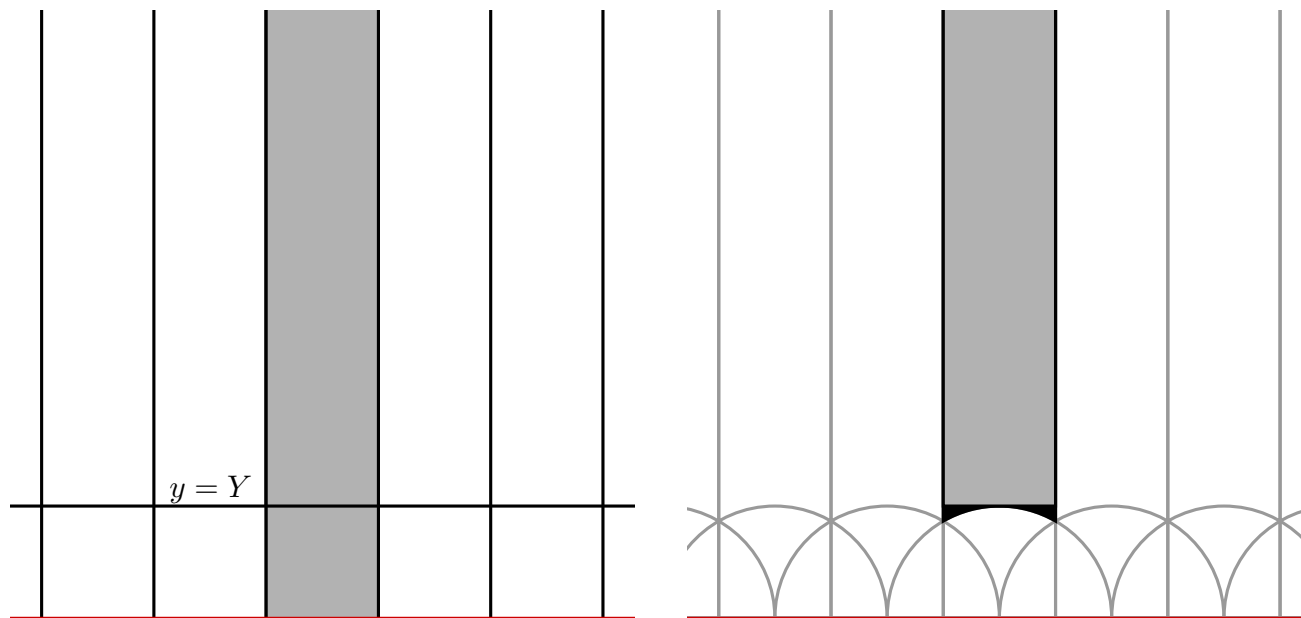

For  $Y \geq 1$ , the region  $\Gamma \cap P \setminus \mathcal{H}^{>Y}$  embeds into  $\Gamma \setminus \mathcal{H}$ . The fundamental domain for  $\Gamma$  is the disjoint union of a simple region and a more complicated but compact one. The simple region retracts nicely onto the cusp at  $\infty$ .

For  $Y > 1$ , the complement of the image of  $\mathcal{H}^{>Y}$  is a manifold with boundary. There is reason to think of the interval  $[i, \infty)$  as the fibre of the tangent bundle at the cusp.

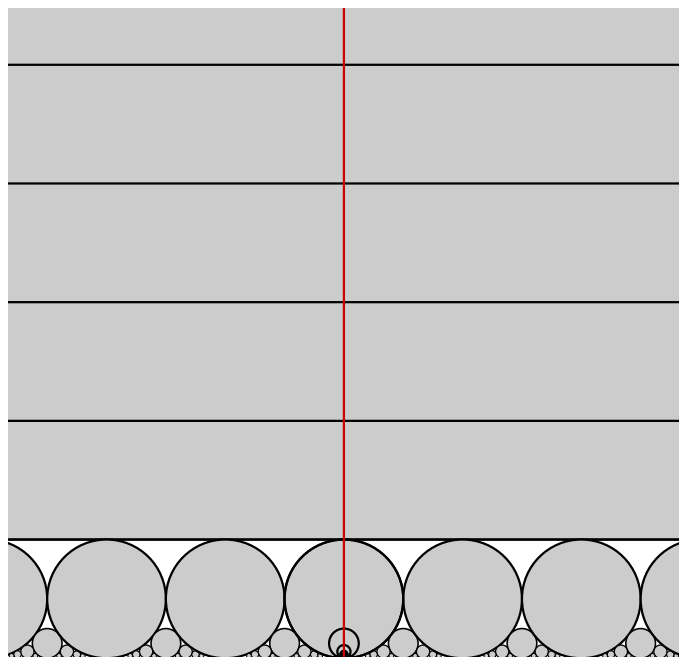

Points of the upper half plane  $\mathcal{H}$  correspond to bases of metric lattices in  $\mathbb{C}$ . They may be normalized to have area 1, so in effect we are considering lattices modulo similarity:

$$z \rightsquigarrow L_z = \mathbb{Z}(1/\sqrt{y}) + \mathbb{Z}(z/\sqrt{y}).$$

The points  $z$  and  $\gamma(z)$  then correspond to isometric lattices. Points in the  $\Gamma$ -translates of  $\mathcal{H}^{>Y}$  may be identified with lattices for which the shortest vector has length  $< 1/\sqrt{Y}$ . This gives a simple classification of points in  $\Gamma \backslash \mathcal{H}$ , into (i) unimodular lattices whose shortest vector has length  $< 1$  and (ii) the rest. To each point in the first category we may associate the parabolic subgroup fixing that shortest vector.

Stuhler and Grayson have pointed out an interesting formulation of this observation in terms of what Grayson calls a **canonical plot**.

To each  $\lambda$  in the (normalized) lattice  $L$  associate the point  $(1, \log \|\lambda\|)$  in the plane. Add points  $(0, 0)$  and  $(2, 0)$  to take into account the full lattice, and plot the associated convex hull:

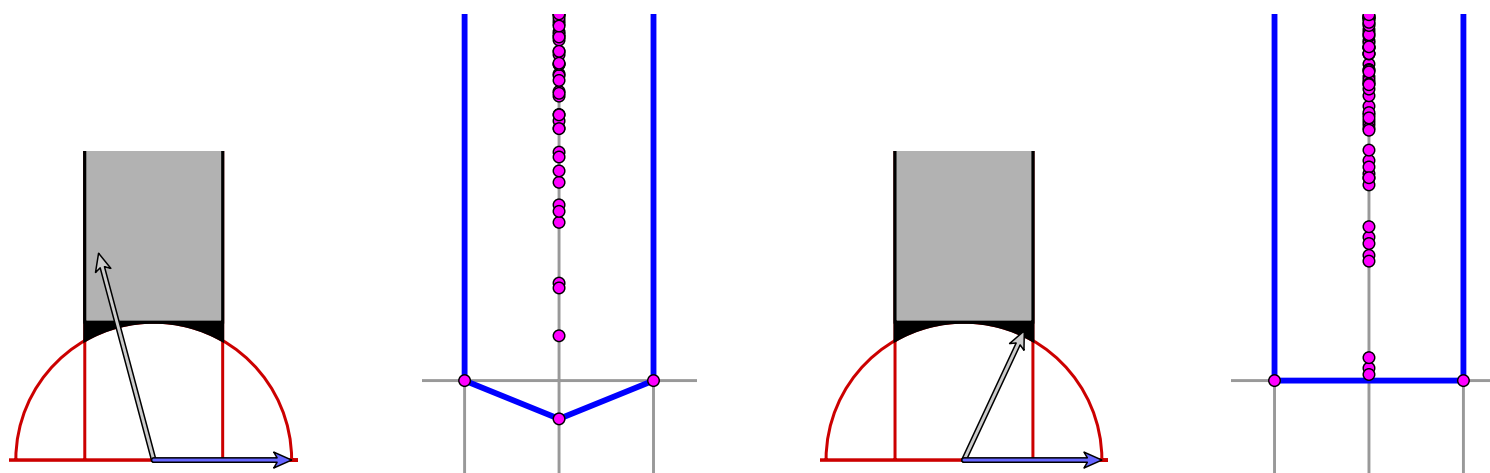

The figure on the left is for  $z = -2/5 + 3i/2, \dots$

$\dots$  that on the right for  $z = 7/16 + 15i/16$ .

The canonical plot depends only on the  $\Gamma$ -orbit of  $z$ . It gives rise to the same partition of  $\mathcal{H}$ , but in different language: one part for which there is a distinct vertex below  $y = 0$ , and the rest, which is compact.



Suppose  $Y \geq 1$ . For any function  $f = \sum_{\mathbb{Z}} f_n(y) e^{2\pi i n x}$  on  $\Gamma \backslash \mathcal{H}$ , define

$$[C^Y f](x + iy) = \begin{cases} f_0(y) & \text{if } y > Y \\ 0 & \text{otherwise} \end{cases}$$

and then

$$[\Lambda^Y f](z) = f - \sum_{\Gamma \cap P \backslash \Gamma} [C^Y f](\gamma(z)).$$

At any given point of  $\mathcal{H}$  the sum is a single term, as long as  $Y \geq 1$ . Note that  $\Gamma$ -invariance is manifest.

We are **partially truncating** the function  $f$  at the line  $y = Y$ . Derivatives of the truncation now involve singular distributions, and this plays a role in the construction of Eisenstein series.

As  $Y \rightarrow \infty$ , the support of the truncation approaches all of  $\Gamma \backslash \mathcal{H}$ , and this formula leads to an estimate of  $E_s$  as a distribution.

- If  $f$  is an automorphic form, then  $\Lambda^Y f$  is rapidly decreasing at  $\infty$ . For example, if

$$f(z) = \sum_{n \geq 0} f_n e^{2\pi i n z}$$

then

$$f(z) - f_0 = O(e^{-2\pi y}).$$

- If  $f$  is in  $L^2(\Gamma \backslash \mathcal{H})$  then  $f = \Lambda^Y f + C^Y f$  is an orthogonal decomposition:

$$\|f\|^2 = \|\Lambda^Y f\|^2 + \|C^Y f\|^2.$$

**Maaß' Eisenstein series is**

$$E_s(z) = \sum_{\Gamma \cap P \setminus \Gamma} \text{IM}^{s/2+1/2}(\gamma(z)).$$

**Its constant term at  $z = x + iy$  is**

$$C_s(y) = y^{1/2+s/2} + c(s)y^{1/2-s/2} \quad \left( c(s) = \frac{\xi(s)}{\xi(1+s)} \right).$$

**Since  $\Delta E_s = \frac{s^2 - 1}{4} E_s$ , Green's Theorem implies that**

$$\Lambda^Y E_s \bullet \Lambda^Y E_t = \int_0^Y C_s(y) C_t(y) \frac{dy}{y^2}$$

**where I am posing**

$$\int_0^Y y^s dy/y = Y^s/s$$

**for all  $s$ . This is the **Maaß-Selberg formula** (a designation apparently due to Harish-Chandra).**

**1.2. Groups of higher rank** Langlands formulated a somewhat complicated generalization of the Maaß-Selberg formula for arbitrary rational reductive groups, employing a version of truncation designed specifically for Eisenstein series. This is to be found in two somewhat enigmatic sections of the written version of his 1965 Boulder talk on Eisenstein series.

The most enigmatic aspect was that Langlands' formulas involved a sum over all *ordered set partitions* of sets of size equal to the rank of the group. It is a mystery as to how and why Langlands came up with them. I am not aware that this notion occurs anywhere else in the subject. One curious feature of his approach is that the treatment is only weakly related to root systems.

8. **A combinatorial lemma.** Before defining the functions  $E''(g, \Phi, \Lambda)$  we had best discuss a simple combinatorial lemma.  $V$  will be a Euclidean space;  $V'$  will be its dual;  $\{\lambda^1, \dots, \lambda^p\}$  will be a basis of  $V'$  such that  $(\lambda^i, \lambda^j) \leq 0$  if  $i \neq j$ ; and  $\{\mu^1, \dots, \mu^p\}$  will be a basis of  $V'$  dual to  $\{\lambda^1, \dots, \lambda^p\}$ . Suppose  $\mathfrak{p}$  is an ordered partition of  $\{1, \dots, p\}$  into  $r = r(\mathfrak{p})$  nonempty subsets  $F_u, 1 \leq u \leq r$ . If  $i \in F_u$  let  $\mu_{\mathfrak{p}}^i$  be the projection of  $\mu^i$  on the orthogonal complement of the space spanned by  $\{\mu^j | j \in F_v, v < u\}$  and let  $\lambda_{\mathfrak{p}}^i, 1 \leq i \leq p$ , be such that  $(\lambda_{\mathfrak{p}}^i, \mu_{\mathfrak{p}}^j) = \delta_{ij}$ . A point  $(\Lambda, \mu_{\mathfrak{p}}^i)$  will be called singular if, for some  $i$  and some  $\mathfrak{p}, (\Lambda, \mu_{\mathfrak{p}}^i) = 0$  or  $(\Lambda, \lambda_{\mathfrak{p}}^i) = 0$

LEMMA 5. *If  $H$  is not singular then*

$$\sum_{\mathfrak{p}} (-1)^{\alpha_{\mathfrak{p}}} \phi_{\mathfrak{p}}^{\Lambda}(H) = \sum_{\mathfrak{p}} (-1)^{\beta_{\mathfrak{p}}} \psi_{\mathfrak{p}}^{\Lambda}(H)$$

*if  $(\lambda^i, \Lambda) < 0$  for some  $i$  and*

$$\sum_{\mathfrak{p}} (-1)^{\alpha_{\mathfrak{p}}} \phi_{\mathfrak{p}}^{\Lambda}(H) = 1 + \sum_{\mathfrak{p}} (-1)^{\beta_{\mathfrak{p}}} \psi_{\mathfrak{p}}^{\Lambda}(H)$$

*if  $(\lambda^i, \Lambda) > 0$  for all  $i$ .*

It is a pleasant exercise to prove this lemma.

9.  **$L^2(\Gamma \backslash G)$  as the bed of Procrustes.** Suppose  $\mathfrak{a} = \mathfrak{a}^{i_0}$  and  $\Phi \in \mathcal{E}(V^{i_0}, W)$  (the notation is that of §4). Suppose  $\Lambda$  in the dual of  $\mathfrak{a}_{\mathbb{C}}$  is such that for all  $i$  and all  $s$  in  $\Omega(\mathfrak{a}, \mathfrak{a}^i)$  the point  $\text{Re}(s\Lambda)$  is not singular in the sense of the previous paragraph. Take  $V$  to be  $\mathfrak{a}^i$  and  $\lambda^1, \dots, \lambda^p$  to be the simple roots of  $\mathfrak{a}^i$ . Suppose also that  $\text{Re}(\Lambda, \alpha) > (\rho, \alpha)$  if  $\alpha$  is a positive root of  $\mathfrak{A}$ . Choose a point  $H_0$  in the split component of the standard parabolic subgroup such that  $\alpha(H_0)$  is very large for every positive root and let  $H_0^i$  be its projection on  $\mathfrak{a}^i$ . For each  $i$  let  $F_i''(g, \Phi, \Lambda)$  be the function

$$\sum_{s \in \Lambda(\mathfrak{a}, \mathfrak{a}^i)} \sum_{\mathfrak{p}} (-1)^{\alpha_{\mathfrak{p}}^{\text{Re}(s\Lambda)}} \phi_{\mathfrak{p}}^{\text{Re}(s\Lambda)}(H^i(g) - H_0^i) \exp(s\Lambda(Hi(g)) + \rho(Hi(g)))((M(s, \Lambda)\Phi)(g)).$$



Truncating the truncator

**In his 1977 Corvallis lectures, Jim Arthur defined truncation in very general circumstances and simplified considerably Langlands' version of Maaß-Selberg. Details were published in 1978/80.**

**It is Arthur's version that has survived. His truncation operator and the M-S formula were (and still are) basic features of his trace formula.**

**There have been few complete expositions of this material since then:**

- **a very prolix paper by M. Scott Osborne (former student of Langlands) and Garth Warner**
- **lecture notes from the 1983 'Friday morning seminar' at the IAS:**
  - (i) **rough notes by Labesse and Langlands**
  - (ii) **the very detailed book by Labesse and Waldspurger.**

**All follow Arthur closely, differing from his account by filling in gaps, simplifying proofs, and correcting small errors.**

## 2. Notation

Following Loren Spice's lead, I have tried to introduce only essential notation:

$G$  = a simple Zariski-connected reductive group, split over  $\mathbb{Q}$ ,  
with a simply connected derived group

$P_\emptyset$  = minimal rational parabolic  
=  $A_\emptyset N_\emptyset$

$\Sigma$  = roots

$\Delta$  = simple roots

$|A|$  = connected component of  $A$ , isomorphic to its Lie algebra  $\mathfrak{a}$

$\theta$  = a canonical involution associated to an épingle

( $x \mapsto {}^t x^{-1}$  on classical groups)

$K = G^\theta$

$\Gamma = G(\mathbb{Z})$

$\mathfrak{Y}^G = G/K$

$\mathfrak{X}^G = G/KA_\Delta$  (a symmetric space)



The group  $\Gamma$  acts discretely on  $\mathfrak{Y}^G$  and  $\mathfrak{X}^G$ , and because of my assumptions on  $G$  and the field of definition

we may identify  $\Gamma \backslash \mathfrak{X}^G$  with  $G(\mathbb{Q}) \backslash G(\mathbb{A}) / K_{\mathbb{R}} A_{\Delta} \cdot \prod G(\mathbb{Z}_p)$ .

It is significant that the canonical involution gives rise to both  $K$  and (according to Chevalley) the integral structure on  $G$ .

It is not true that all parabolic subgroups are created equal—the choice of  $\theta$  and integral structure distinguishes some. *The  $P_{\Theta}$  are special.* So special that in referring to them in subscripts or superscripts I shall often write just  $\Theta$ .

The group  $\Gamma$  acts transitively on each  $P_{\Theta}(\mathbb{Q}) \backslash G(\mathbb{Q})$ . There exists a simple variant of the Euclidean algorithm making explicit  $P_{\emptyset}(\mathbb{Q}) \backslash G(\mathbb{Q}) = \Gamma \cap P_{\emptyset} \backslash \Gamma$ .

For simplicity of notation, I shall generally confine myself to looking at  $\Gamma \backslash \mathfrak{Y}^G$  and  $\Gamma \backslash \mathfrak{X}^G$  rather than  $\Gamma \backslash G$ . One simplification is that, since  $P$  acts transitively on  $\mathfrak{X}^G$ ,  $N_P(\Gamma \cap P) \backslash \mathfrak{Y}^G$  may be identified with  $\Gamma \cap M \backslash \mathfrak{Y}^M$ .

If  $P$  is minimal, there is a canonical map from  $P$  to  $A_\emptyset$ . In other cases, there is a canonical map to the maximal torus quotient of  $M$ , and this is isogenous to  $A_P$ .

Now suppose  $P = P_\Theta$ . Then  $P$  acts transitively on  $\mathfrak{X}^G$ . Combining these remarks, there is a well defined real analytic map from  $\mathfrak{X}^G$  to  $|A_P|$ , and then via the exponential we get a homomorphism

$$\sigma_\Theta: N_\Theta(\Gamma \cap P_\Theta) \backslash \mathfrak{X}^G \longrightarrow \mathfrak{a}_\Theta / \mathfrak{a}_\Delta.$$

If  $P = \gamma P_\Theta \gamma^{-1}$  define  $\sigma_P(x) = \sigma_\Theta(\gamma^{-1}x)$ . (This maps to  $\mathfrak{a}_\Theta$ , not  $\mathfrak{a}_P$ ! I remind you, this is not a democracy.)

In  $\mathfrak{a}_\Theta$  let  $\mathfrak{a}_\Theta^+$  be the obtuse root cone,  $\mathfrak{a}_\Theta^{++}$  its acute dual. If  $P = P_\emptyset$

$$\begin{aligned} \mathfrak{a}_\emptyset^{++} &= \{a \mid |\langle \alpha, a \rangle| > 0 \text{ for all } \alpha \in \Delta\} \\ \mathfrak{a}_\emptyset^+ &= \{a \mid |\langle \varpi, a \rangle| > 0 \text{ for all } \varpi \in \widehat{\Delta}\}. \end{aligned}$$

$$\nabla_\Theta^\Delta = \text{characteristic function of } \mathfrak{a}_\Theta^{++}$$

$$\square_\Theta^\Delta = \text{characteristic function of } \mathfrak{a}_\Theta^+$$

In Arthur, these are  $\tau$  and  $\widehat{\tau}$ , but I find this notation easier to read.

Any of these can be pulled back via  $\sigma_P$  to functions  $\nabla_P^G, \square_P^G$  on  $N_P(\Gamma \cap P) \backslash \mathfrak{Y}^G$ .

### 3. Toy models

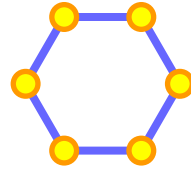

Two ridiculously simple models help me to understand what's going on.

In order to put things in context I begin with something very general. Suppose  $C$  to be an arbitrary convex polytope in  $\mathbb{R}^n$  defined by affine inequalities  $f_i \leq 0$ . If  $F$  is a face of  $C$ , define the exterior  $E_F^C$  of  $F$  to be the region in which  $f_i > 0$  for all  $f_i = 0$  on  $F$ :

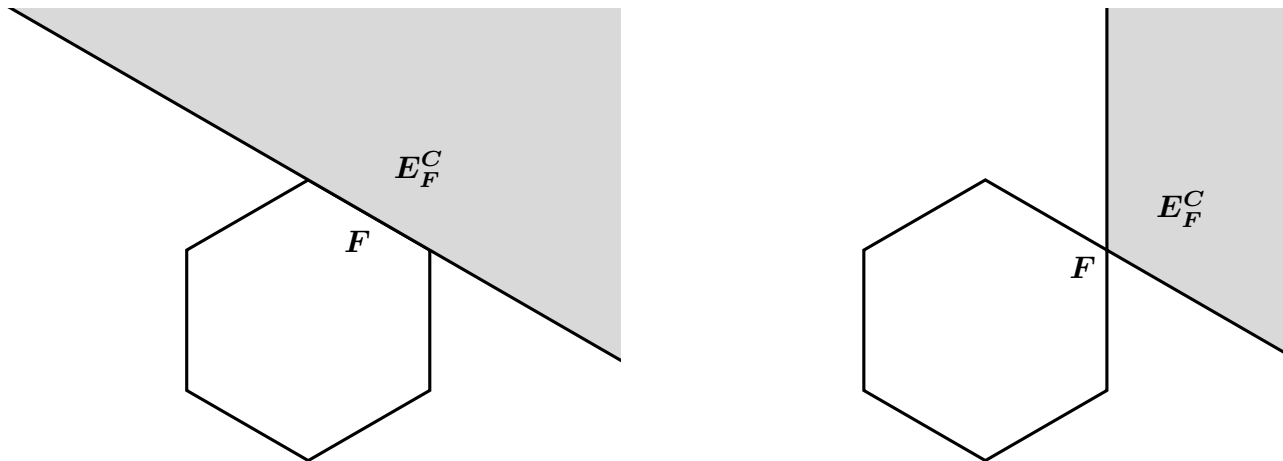

The exterior of  $C$  itself is taken to be all of  $\mathbb{R}^n$ .

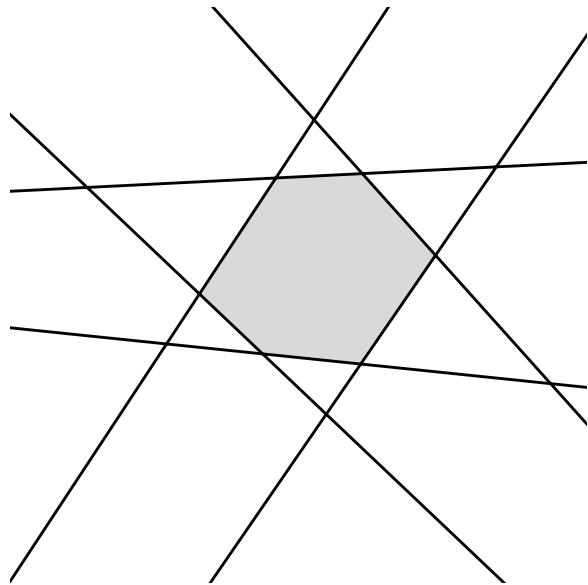

**Magically:**

**Theorem.** (Truncation formula)

$$\text{char}_C = \sum_F (-1)^{\text{codim}(F)} \text{char}_{E_F^C} .$$

The proof is not complicated. It amounts to verifying that the Euler characteristic of the complexes of ‘visible’ faces vanishes.

We shall be interested in only two cases:  
 (i)  $C$  is a simplicial cone and (ii)  $C$  is the convex hull of a Weyl group orbit.

In case (i) we are looking at the tiling by coordinate octants. I leave it as an exercise.

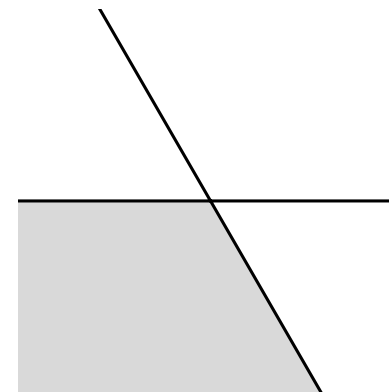

The previous result is related to the tiling of a vector space by coordinate octants. Another tiling we shall be interested in is a modification of that determined by nearest faces in the negative octant  $C$ .

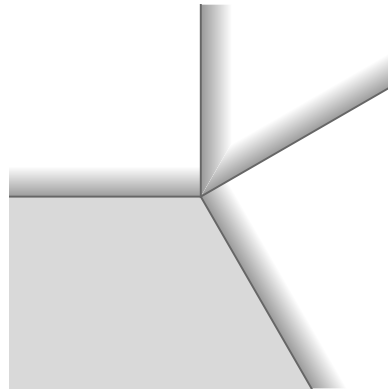

We can apply the truncation formula to each cylinder over a face of  $C$ . This leads to a basic result. If  $\Delta$  is an obtuse basis,  $\hat{\Delta}$  its (acute) dual, and  $\Theta \subseteq \Delta$ , let

$$\Xi_{\Theta} = \text{conical span of } \hat{\Theta} \text{ and } \Delta - \Theta.$$

**‘Combinatorial lemma’.**

$$\sum_{S \subseteq \Delta} (-1)^{|\Theta|} \cdot \text{char } \Xi_{\Theta} = 0.$$

*except when  $\Delta = \emptyset$ .*

This formula makes up the links in a chain between the nearest face partition and the coordinate tiling.

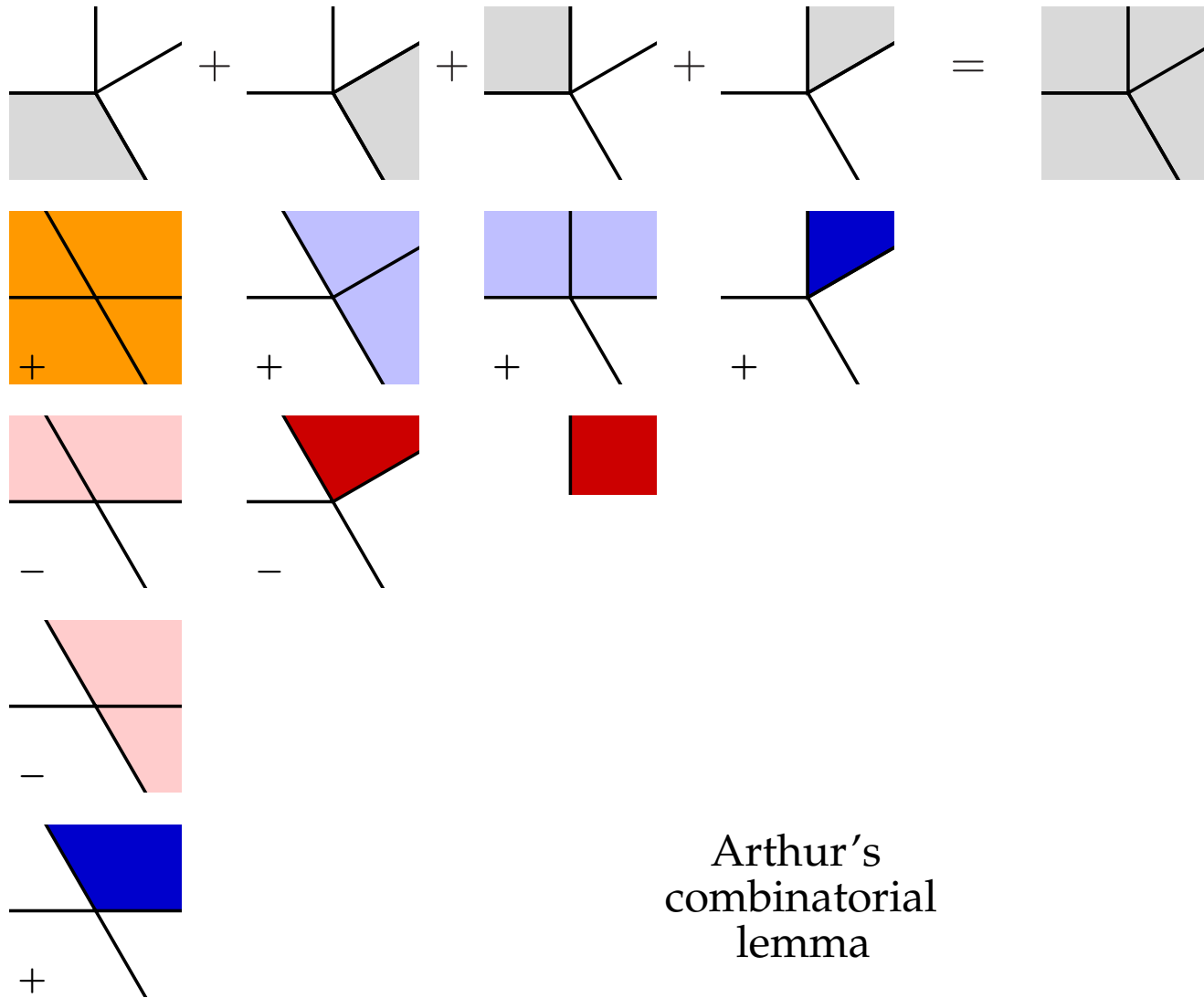

The second simple model is the convex hull of an orbit of a point  $T$  in the positive chamber with respect to the Weyl group. We consider a technical modification of the nearest face partition.

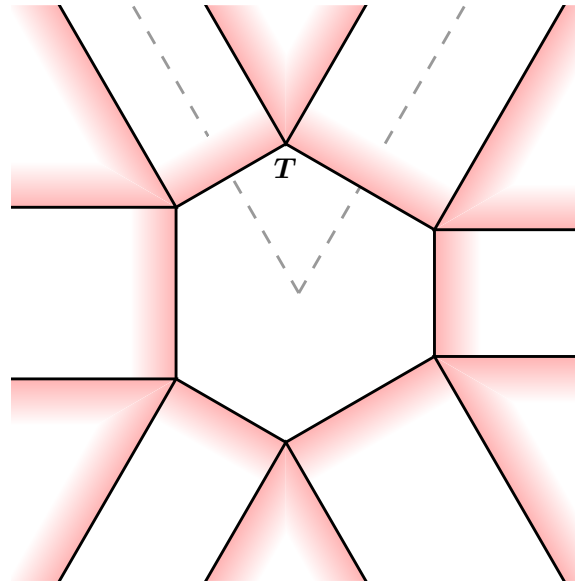

The truncation formula becomes

$$[\text{char } \mathcal{C}^T](v) = \sum_{\Theta} (-1)^{|\Delta - \Theta|} E_{W_{\Theta}}^W (\text{shaded } \Delta_{\Theta}(w \cdot (v - T))).$$

This looks a little more relevant to automorphic forms, and in fact this diagram is in some sense embedded in the space  $\mathfrak{X}^G$ , as we shall see. It is related to a compactification of the torus  $A_{\theta}$ , for which orbits are parametrized by faces of  $\mathcal{C}_T$ . We are looking at neighbourhoods of the components at  $\infty$  in this compactification.

What I call the truncation formula is related to some well known results in classical geometry going back to the 19th century, but I learned it from a paper of Michel Brion. He uses it to find a striking formula for the Fourier transform of convex polyhedra in terms of the tangent cones at vertices. This formula amounts to an analogue of Maaß-Selberg!

Incidentally, Brion is also interested in lattice polytopes and, as Labesse has pointed out to me, these appear in the trace formula for groups over function fields.

It's a curious formula, and I find it puzzling.

*Any smooth convex polytope is the limit of ones with a finite number of faces. Is there a limiting theorem?*



## 4. Partition

Arthur's truncation is intimately related to partitions of  $\mathfrak{X}^G$  generalizing the classical one for  $SL_2$ . What I believe to be the optimal way to construct this partition can be found in work of Stuhler, Grayson, and Harder. It offers an alternative (and more precise) reduction theory for arithmetic groups that doesn't use Siegel sets.

I'll look first at the cases  $SL_n$  and  $GL_n$ , and then tell you roughly what happens (or, at least, presumably happens) for other groups.

The space  $GL_n/O_n$  parametrizes positive definite quadratic forms on  $\mathbb{R}^n$ :

$$X \mapsto \|v\|_X^2 = {}^t v (X \cdot {}^t X) v.$$

Consider for each one of these the restriction of the form to  $L = \mathbb{Z}^n$ . To this datum I associate what Grayson calls its **canonical plot** and its **canonical profile**. Scale  $L$  so its volume becomes 1—in effect, we are looking at metric lattices modulo similarity. To any sublattice  $M \subseteq L$  of dimension  $m$  associate the point  $(m, \log \text{vol}(M))$  in  $\mathbb{R}^2$ . By convention the point 0 has volume 1, and by assumption the lattice  $L$  has volume 1.

The set of all such points is the lattice's plot. Its profile is the convex hull. It is bounded below.

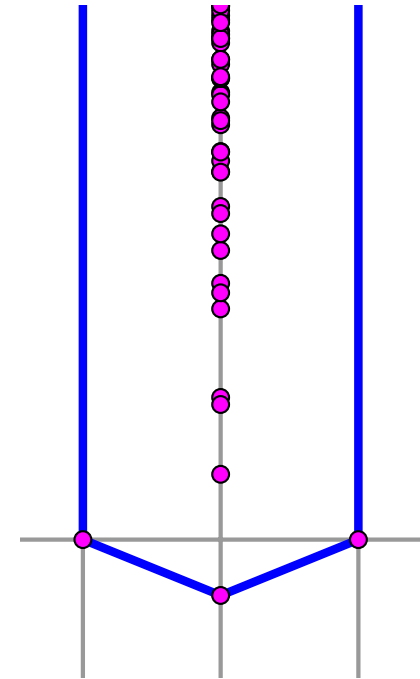

For another example, suppose

$$\alpha = (1, 1, 2)$$

$$\beta = (2, 0, -3)$$

$$\gamma = (2, 1, 5)$$

Scale them so the parallelepiped they span has volume 1.

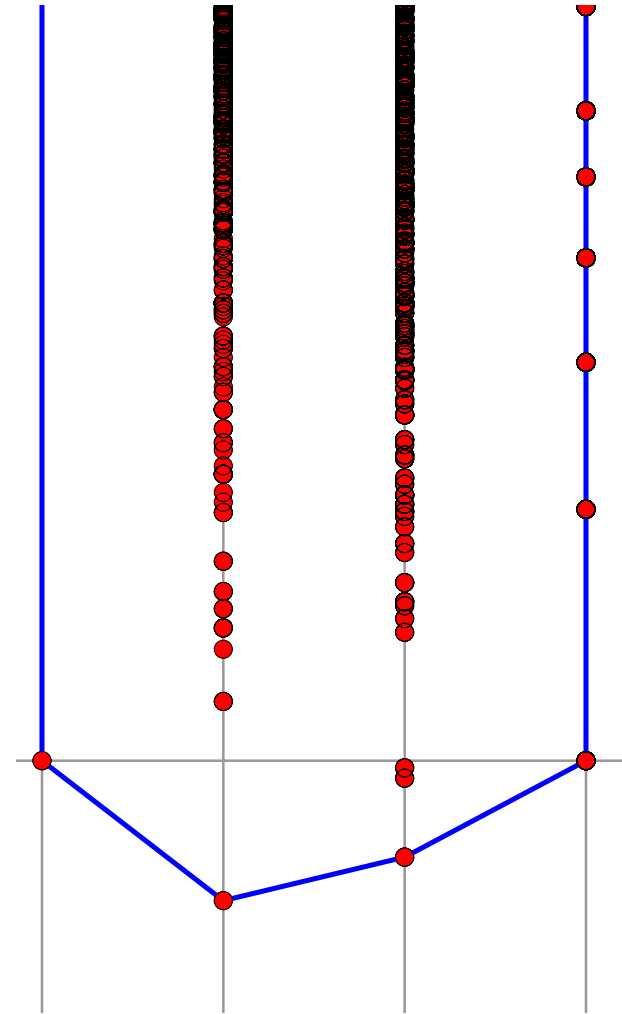

For a group of rank three there are four basic types of profile:

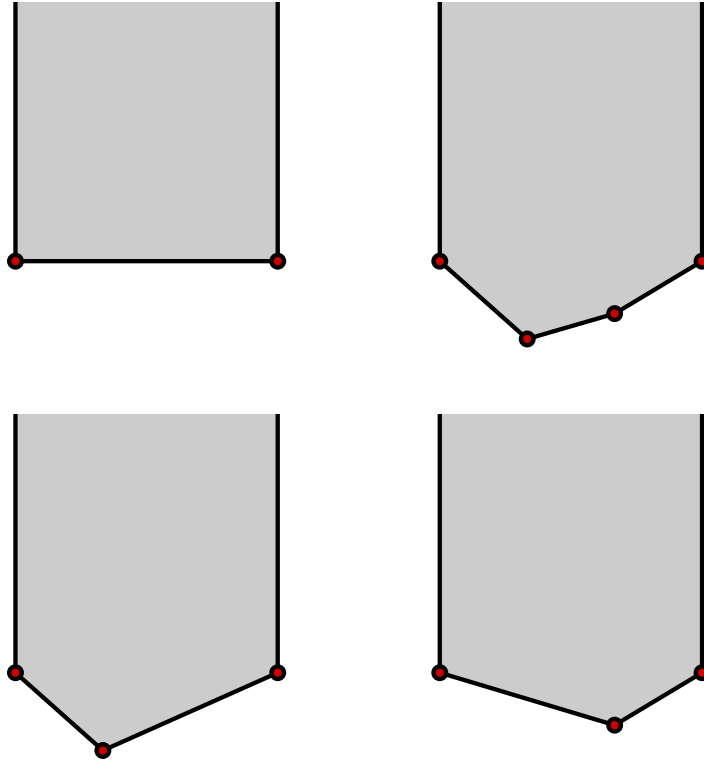

The main theorem is due to Ulrich Stuhler, with improvements by Dan Grayson:

**Theorem.** *The vertices of the profile arise from a flag in  $\mathbb{R}^n$ .*

It is the **canonical flag**. Its stabilizer is a rational parabolic subgroup. The points for which this is  $P$  make up a set  $\mathfrak{X}_P^G$ . We therefore have a **canonical partition** of  $\mathfrak{X}^G$  parametrized by rational parabolic subgroups.

For  $\gamma$  in  $\mathrm{GL}_n(\mathbb{Z})$

$$\mathfrak{X}_{\gamma P \gamma^{-1}}^G = \gamma \mathfrak{X}_P^G.$$

The set  $\mathfrak{X}_P^G$  is stable under  $N_P$  and  $\Gamma \cap P$ . The partition is compatible with the action of  $\Gamma$ .

**Corollary.** *The canonical maps*

$$\begin{array}{ccc} & & \Gamma \backslash \mathfrak{X}^G \\ & \nearrow & \\ \Gamma \cap P \backslash \mathfrak{X}_P^G & & \\ & \searrow & \\ & & \Gamma \cap P \backslash \mathfrak{X}^G \end{array}$$

*are embeddings.*

The union  $\bigcup_{Q \subseteq P} \mathfrak{X}_Q^G$  is also stable under  $\Gamma \cap P$  and its quotient also embeds into  $\Gamma \backslash \mathfrak{X}^G$ .

For  $SL_2$ , we get a familiar picture:

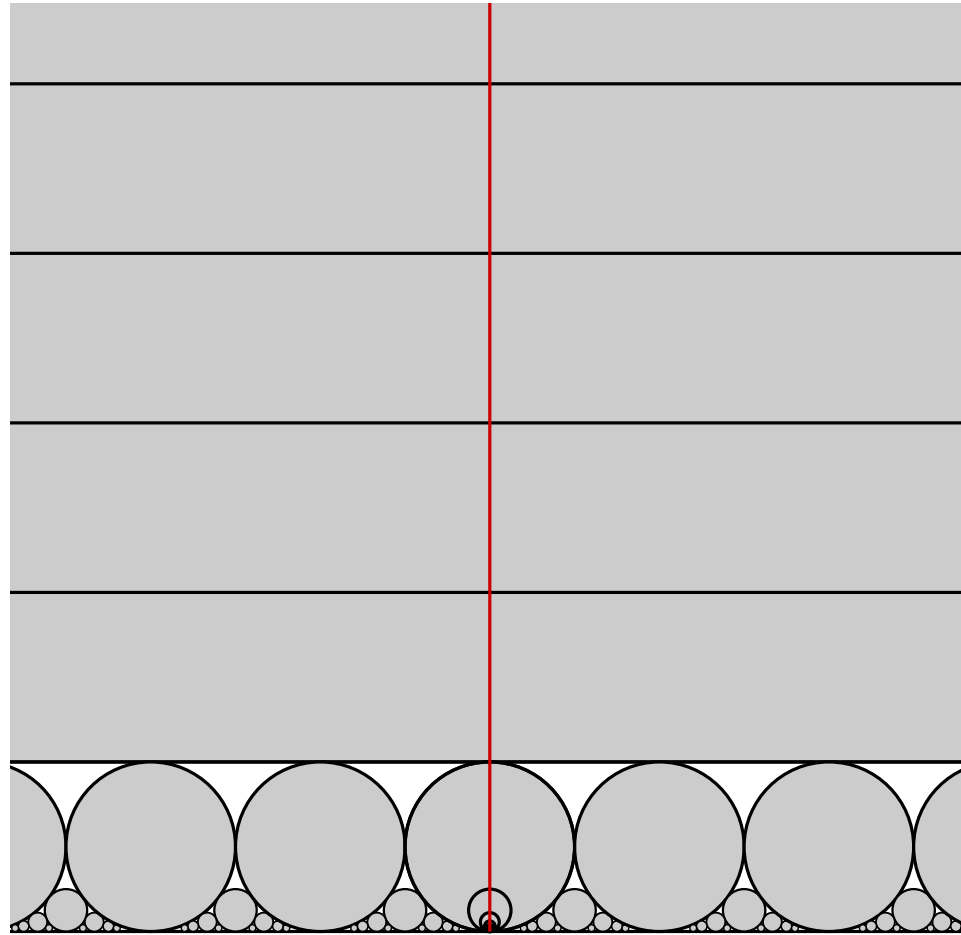

Suppose  $P$  to be a rational parabolic subgroup. Then  $\mathfrak{X}^G = P/(K \cap P)A_G$ , and hence there exist projections

$$\begin{aligned} \mathfrak{X}^G &\longrightarrow \mathfrak{X}^M \quad (\text{a boundary component in a Satake compactification}) \\ \mathfrak{X}^G &\longrightarrow \mathfrak{a}_P/\mathfrak{a}_G. \end{aligned}$$

**Theorem.** If  $P = P_\Theta$  then

$$\mathfrak{X}_P^G = \pi_P^{-1}(\mathfrak{X}_M^G) \cap \sigma_P^{-1}(\mathfrak{a}_P^{++}/\mathfrak{a}_G).$$

In this case, I'll write  $\pi_\Theta$  and  $\sigma_\Theta$ .

This assertion is not true for arbitrary  $P$ , probably only for the  $\gamma P_\Theta \gamma^{-1}$  for  $\gamma$  in  $\Gamma \cap K$ . The defect is a measure of Diophantine height. For a general  $P = \gamma P_\Theta \sigma^{-1}$  I therefore define

$$\sigma_P(x) = \sigma_\Theta(\gamma^{-1}x).$$

Define  $\square_P^G, \nabla_P^G$  accordingly.

**The proof of the Theorem depends on an explicit description of the canonical plot in terms of roots.**

**The canonical profile is easily computed on the  $A_\emptyset$ -orbit of the point fixed by  $O_n$ . It suffices to see what happens in the closed fundamental Weyl domain. If  $a$  is the diagonal matrix with entries  $(a_i)$  and  $a_i \geq a_{i+1}$ , we assume normalized so  $\prod a_i = 1$ .**

**Let  $\varepsilon_i = \log a_i$ , so  $\sum \varepsilon_i = 0$ . The shortest vector in  $\varepsilon^m \mathbb{Z}^n$  has length  $a_{n-m+1} \cdots a_n = 1/a_1 \cdots a_{n-m}$ , so the corresponding profile vertex has  $y = -\varepsilon_1 - \cdots - \varepsilon_{n-m}$ . This is the same as the evaluation of the fundamental weight  $-\varpi_{n-m}$  at  $a$ . The slopes of the lines are the  $\varepsilon_m$ , and the difference in slopes are the  $\varepsilon_{m-1} - \varepsilon_m$ , which is the root  $\alpha_{m-1}$ . Since the profile is convex, this leads to the condition  $\alpha_i > 0$  for all  $i$ .**



Other, closely related, partitions  $\mathfrak{X}_P^{G,T}$  are parametrized by points  $T$  in  $A_\emptyset^{+++}$ , requiring bounds of various kinds on the canonical plot.

The assignment of canonical plots is a good substitute for a visualization of  $\mathfrak{X}^G$ . Another attempt at visualization can be obtained by restricting the partition to  $A_\emptyset$ . We recover the nearest face partition in the simple model! The parabolic subgroups involved are those containing  $A_\emptyset$ .

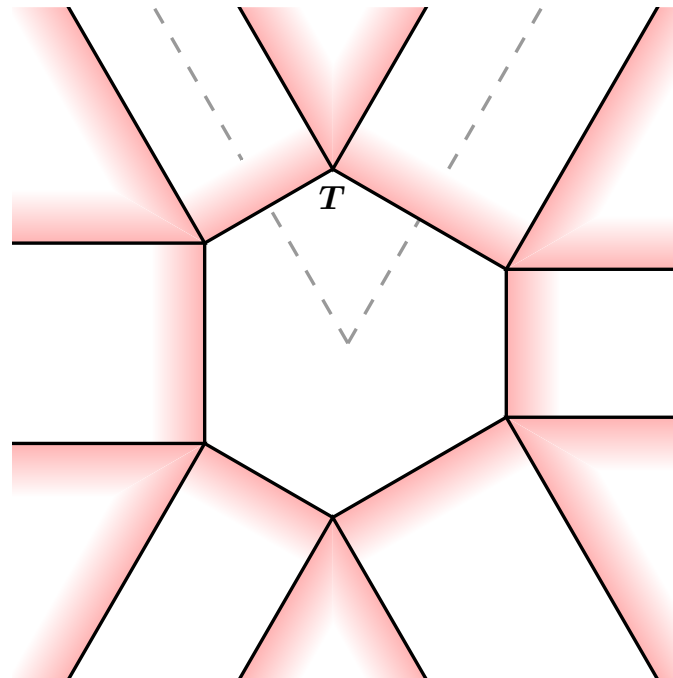

Inspiration for Stuhler's construction came from results of Harder and Narasimhan classifying vector bundles on algebraic curves, following Mumford's description of moduli. In agreement with this, points in  $\mathcal{X}_G^G$  are called **semi-stable**. An explicit description of the semi-stable sets except in low dimensions is not feasible—they are merely the ones that are not associated to a proper parabolic subgroup.

Any parabolic subgroup  $P$  acts transitively on  $\mathcal{X}^G$ . To this are assigned  **$P$ -profiles** attached specifically to the flag stabilized by  $P$ . Each  $P$  gives a different partition of  $\mathcal{X}^G$  associated to parabolic subgroups contained in  $P$ . This is a bit technical to describe here, but it is a basic tool in proving basic results about truncation. What is important is that the  $P$ -profile is contained in the  $Q$ -profile if  $P \subseteq Q$ . Consequently, the  $P$ -profile gives a minimal bound on the  $G$ -profile.

The situation for  $SL_n$  and  $GL_n$  is just about ideal. Grayson has extended these sharp results to some classical groups. He has also extended his techniques to lattices in the Lie algebra  $\mathfrak{g}$ , and managed to reprove in these terms, without referring to Siegel sets, the classical results of reduction theory for arbitrary rational reductive groups.

Kai Behrend found a related partition for groups over function fields, replacing lattices by integral group schemes and profiles by a **complementary polyhedron**. Harder and Stuhler have applied Behrend's techniques to rational groups, working with  $G(\mathbb{Q}) \backslash G(\mathbb{A})$  instead of  $\Gamma \backslash G(\mathbb{R})$ , but although it is promising there doesn't seem to be a definitive result. Their work has been explained only in a series of informal notes.

One problem for me is that I don't see that what they say for split orthogonal groups is compatible with what Grayson says. Nor do I see how to deal with  $P$ -profiles.

There are some interesting modifications necessary when the group is not split. On the one hand, Grayson's examples suggest that the optimal result will be related to the degree of ramification of the group, although it is not clear to me just how. On the other, it is also related to the parameter  $T_0$  occurring in Arthur's work.

## 5. Truncation

**5.1. Crude truncation** The partition of  $\mathfrak{X}^G$  by the  $\mathfrak{X}_P^G$  leads to a crude truncation, multiplication by characteristic functions. There is then an obvious decomposition of a function on  $\Gamma \backslash \mathfrak{X}^G$  into a sum of ones with support on  $\Gamma \backslash \mathfrak{X}_P^G$ , which may be identified with a function on  $\Gamma \cap P \backslash P$ .

More precisely, define

$$\Omega_P^G(F) = \text{char}_{\mathfrak{X}_P^G} \cdot F,$$

and then because the  $\mathfrak{X}_P^G$  are a disjoint partition

$$F = \sum_P \Omega_P^G(F)$$

is an orthogonal decomposition.

If  $F$  is invariant with respect to  $\Gamma$ , then so is each partial sum over  $\Gamma$ -conjugacy classes. But since such conjugacy classes are  $\Gamma$ -conjugates of some  $P_\Theta$  we can also write

$$F = \sum_{\Theta} E_{P_\Theta}^G (\Omega_{P_\Theta}^G (F)).$$

The series  $E_{P_\Theta}^G = E_\Theta^\Delta$  is

$$\sum_{\Gamma \cap P_\Theta \backslash \Gamma} [\Omega_\Theta^\Delta (F)](\gamma x).$$

Since  $\Gamma \cap P$  is the stabilizer of  $\mathfrak{X}_P^G$ , each term in our series is a singleton.

This orthogonal decomposition together with the ‘combinatorial lemma’ allows us to deduce an analogue of the truncation formula. Recall that  $\mathbb{1}_P^G$  is the characteristic function of the inverse image of the obtuse root cone in  $\mathfrak{a}_P/\mathfrak{a}_G$ . We deduce

$$\Omega_G^G(F) = \sum_P (-1)^{\text{corank}(P)} \mathbb{1}_P^G \cdot F$$

The sum here is over all rational parabolic subgroups, and may be replaced by a sum of Eisenstein series associated to standard ones. This suggests that  $\mathfrak{X}_G^G$  is in some sense a convex figure in  $\mathfrak{X}^G$ , but I don’t know how to make this observation worth anything.

**5.2. Arthur's truncation** Recall that  $\mathfrak{Y}^G = G/K$ . There is a canonical projection to  $\mathfrak{X}^G = \mathfrak{Y}^G/A_G$ , and I define  $\mathfrak{Y}_P^G$  to be the inverse image of  $\mathfrak{X}_P^G$ .

For  $F$  a function on  $\Gamma \backslash \mathfrak{Y}^G$  its **constant term** with respect to  $P = MN$

$$F_P(x) = \int_{\Gamma \cap N \backslash N} F(nx) dn,$$

which is a function on  $(\Gamma \cap P)N \backslash \mathfrak{Y}^G$ .

The example of  $SL_2$  and the formula for crude truncation suggests how to define a **fine** truncation:

$$\Lambda_G^G(F) = \sum_P (-1)^{\text{corank}(P)} \mathfrak{I}_P^G \cdot F_P = \sum_\Theta (-1)^{|\Delta - \Theta|} E_\Theta^\Delta (\mathfrak{I}_\Theta^\Delta \cdot F_\Theta).$$

Here  $F_\Theta$  is the constant term for  $P_\Theta$ .

**This is exactly Arthur's definition!**

Introduce the parameter  $T$  in the truncation. From remarks made earlier about  $P$ -profiles and partitions:

**Proposition.**  $\Lambda_G^{G,T} F$  agrees with  $F$  on  $\mathfrak{Y}_G^{G,T}$ .

This implies that as  $T \rightarrow \infty$ ,  $\Lambda_P^{G,T}$  approximates  $F$  better and better.

Of course similar definitions are valid for each Levi factor  $M$ .



We would like now to have an analogue of the projections associated to parabolic subgroups.

The group  $P = P_\Theta$  still acts transitively on  $\mathfrak{Y}^G$ , so  $N_P(\Gamma \cap P) \backslash \mathfrak{Y}^G$  may be identified with  $\Gamma \backslash \mathfrak{Y}^M$ . The function  $\nabla_\Theta$  may be pulled back from  $\mathfrak{X}^G$  to  $\mathfrak{Y}^G$ . The function

$$\nabla_\Theta^\Delta \cdot \Lambda_\Theta^\Theta(F_\Theta)$$

is a function on  $\mathfrak{Y}^G$  that is left-invariant under  $(\Gamma \cap P)N_P$ . It has support on  $\sigma_P^{-1}(\mathfrak{a}_P^{++})$  but not generally on  $\mathfrak{X}_P^G$ .

Set

$$\Lambda_\Theta^\Delta(F) = E_\Theta^\Delta(\nabla_\Theta^\Delta \cdot \Lambda_\Theta^\Theta(F_\Theta)).$$

From the definition of Arthur's truncation, together with the combinatorial lemma, we now deduce a 'truncation decomposition'

$$F = \sum_\Theta E_\Theta^\Delta(\Lambda_\Theta^\Delta(F)).$$

**5.3. Questions** This is suggested by the finite model, and is well known:

**Proposition.** Assume  $\gamma$  to be in  $\Gamma$ , and suppose  $\Phi = \Lambda_G^G F$ . Then  $\Phi_P(x) = 0$  unless  $\sigma_P(x)$  lies in the region  $\bar{a}_\Theta^-$ .

**Corollary.** The operator  $\Lambda_G^G$  is an orthogonal projection.

That is to say, it is idempotent and symmetric. The standard proofs remain valid here.

These lead to some natural questions:

- (a) *Is  $\Lambda_P^G$  an orthogonal projection?*
- (b) *If so, is there a good formula for  $\|\Lambda_P^G F\|_{\Gamma \setminus G}^2$ ?*

Regarding (a), it is easy to verify that  $\Lambda_\Theta^\Delta F \bullet \Lambda_\Omega^\Delta F = 0$  if  $\Theta \subset \Omega$ . This also seems to be true for low rank groups, and looks likely in general to be an interesting exercise in Weyl group geometry.

Claim (b) is more interesting. Here is a strong version:

$$\|\Lambda_P^G F\|_{\Gamma \setminus \mathfrak{X}^G}^2 = \|\Lambda_P^G F\|_{N_P(\Gamma \cap P) \setminus \mathfrak{X}^G}^2 ?$$

On Mondays, Wednesday, and Fridays it seems to me that it is true and on Tuesdays, Thursdays, and Saturdays that it is impossible. The best evidence I have for it comes from some heuristics about the Maaß-Selberg formula. I do not know what happens even for  $SL_3$ . But hey! today is Friday ...

**There would be a number of pleasant consequences. One would be a simplification of the construction of Eisenstein series associated to cusp forms. One could also find a simpler derivation of the Plancherel formula for Eisenstein series. Most interesting, one might perhaps find a new construction of Eisenstein series associated to square-integrable automorphic forms.**

**This in turn should lead to a version of the trace formula hinted at by work of Sakellaridis.**

## 6. References

### 6.1. Partition

- Ichiro Satake, ‘**On compactifications of the quotient spaces of locally symmetric spaces**’, *Annals of Mathematics*, 1960.
- Ulrich Stuhler, ‘**Eine Bemerkung zur Reduktionstheorie quadratischen Formen**’, *Archiv der Mathematik* 27 (1976), 604.
- Daniel Grayson, ‘**Reduction theory using semi-stability I and II**’, *Comment. Math. Helvetici* 59 (1984), 600–634 and *Comment. Math. Helvetici* 61 (1986), 661–676.
- C —, ‘**Stability of lattices and the partition of arithmetic quotients**’, *Asian Journal of Mathematics* 8 (2004), 607–637.
- Günter Harder and Ulrich Stuhler, ‘**Canonical parabolic subgroups of Arakelov group schemes**’ preprint dated 2003. Available at  
<https://www.uni-math.gwdg.de/stuhler/preprints.html>

This is one of a sequence of preprints, originally based on lectures at a summer school in Trieste. None seems to be complete.

## 6.2. Truncation

- Robert P. Langlands, ‘**Eisenstein series**’, in the proceedings of the 1965 Boulder conference.

- ——— and Jean-Pierre Labesse, proceedings of the Friday morning seminar:

<http://www.math.ubc.ca/~cass/Langlands/friday/friday.html>

Particularly Lectures 1, 2 and 6 by Langlands, as well as the Erratum at the end of Lecture 3 and Lecture 13 by Labesse.

- James Arthur, ‘**Eisenstein series and the trace formula**’, in the proceedings of the Corvallis conference of 1977.

- ———, ‘**A trace formula for reductive groups I: terms associated to classes in  $G(\mathbb{Q})$** ’ *Duke Mathematical Journal* **45** (1978), 911–952.

- ———, ‘**A trace formula for reductive groups II: applications of a truncation operator**’, *Compositio Mathematica* **40** (1980), 87–121.

- ———, ‘**The trace formula in invariant form**’, *Annals of Mathematics* **114** (1981), 1–74.

- Jean-Pierre Labesse and Jean-Louis Waldspurger, **The twisted trace formula** (in French), AMS.

### 6.3. Eisenstein series

- Werner Müller, ‘**The trace class conjecture in the theory of automor[phic forms]**’, *Annals of Mathematics* **130** (1989), 473–529.
- C —, ‘**Extended automorphic forms on the upper half-plane**’, *Mathematischen Annalen* **296** (1993).
- ———, ‘**Harmonic analysis of the Schwartz space of  $\Gamma \backslash \mathrm{SL}_2(\mathbb{R})$** ’, in **Contributions to automorphic forms, geometry, and number theory**, Johns Hopkins Press, 2004.
- ———, ‘**A conjecture about the analytical behaviour of Eisenstein series**’, *Pure and Applied Mathematical Quarterly* **1** (2005), 867–888.
- Yiannis Sakellaridis, ‘**The Selberg trace formula revisited**’,  
<https://arxiv.org/abs/1710.01866>

**Thank you!**