

# ***INCREMENTALITY IN MODEL TRANSFORMATION WITH TRIPLE GRAPH GRAMMARS***

Fernando Orejas, UPC (Barcelona)

In cooperation with

Elvira Pino, UPC (Barcelona)

# Consistency

$$\emptyset \leftrightarrow \emptyset \Longrightarrow p_1 \quad \dots \quad \Longrightarrow p_n \quad G_S \leftrightarrow G_T$$

# Model Transformation

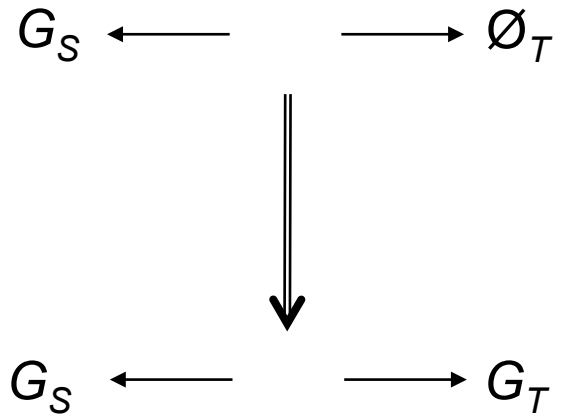

$$G_S \leftrightarrow \emptyset \quad \Longrightarrow_{p_1^F} \quad \dots \quad \Longrightarrow_{p_n^F} \quad G_S \leftrightarrow G_T$$

# Model synchronization

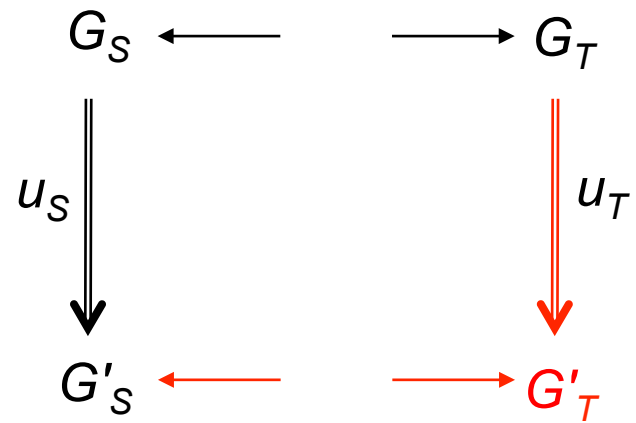

## *Incremental model synchronization*

Model synchronization is incremental if we build  $G'_T$  reusing (parts of / as much as possible of)  $G_T$

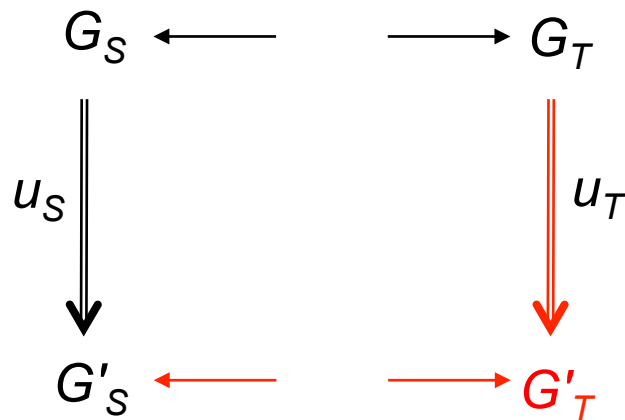

## *Incremental model synchronization*

Model synchronization is incremental if its computational cost depends on the size of  $u_S$  rather than on the size of  $G_S$ ,  $G'_S$  and  $G_T$ .

H.Giese, R. Wagner: From model transformation to incremental bidirectional model synchronization. SoSym 8, 21–43 (2009)

# Non-incremental Model Synchronization

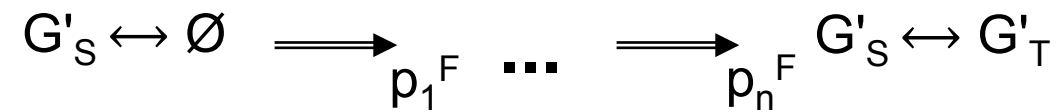
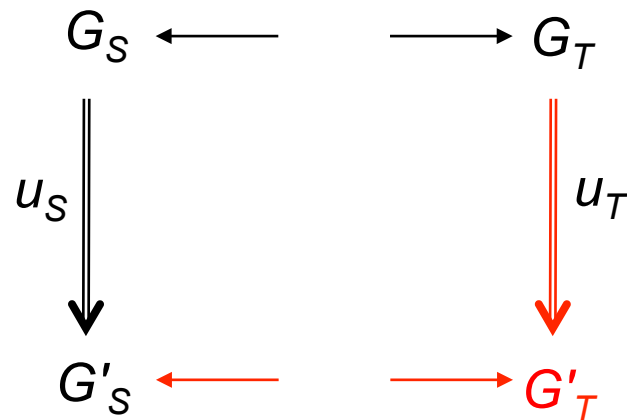

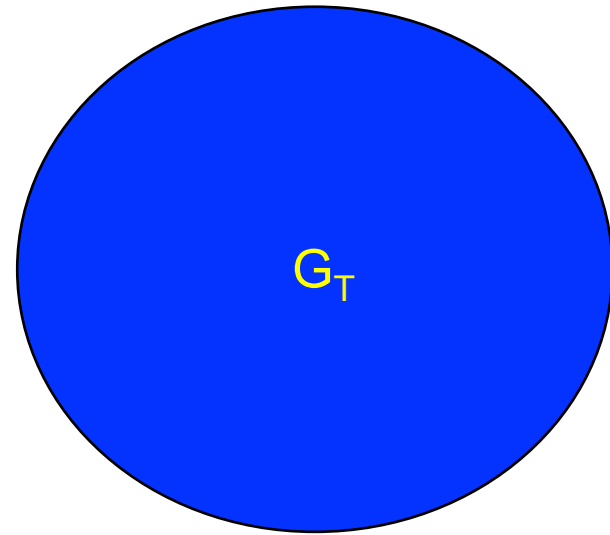
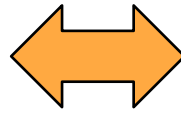

$\emptyset \leftrightarrow \emptyset \implies \dots \implies G_S \leftrightarrow G_T$

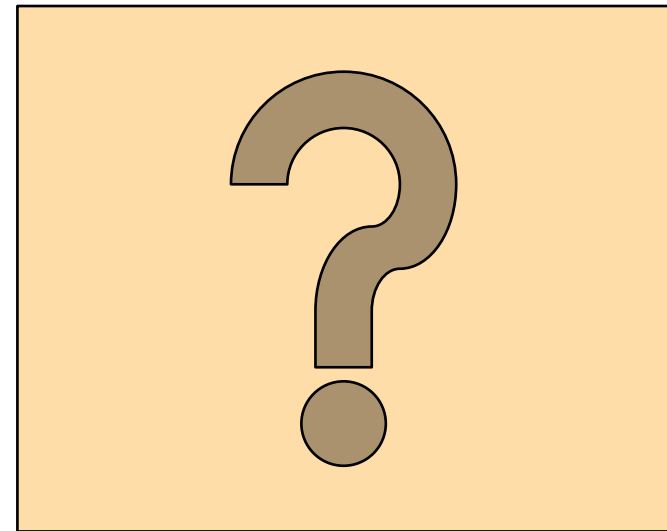
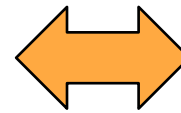
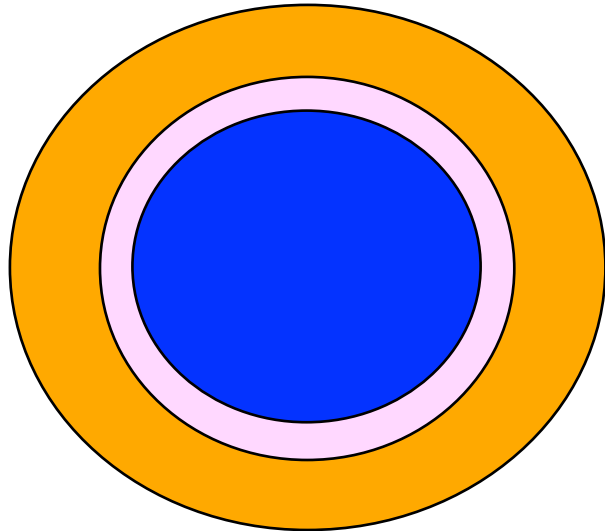
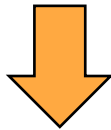



## *Transformation rules*

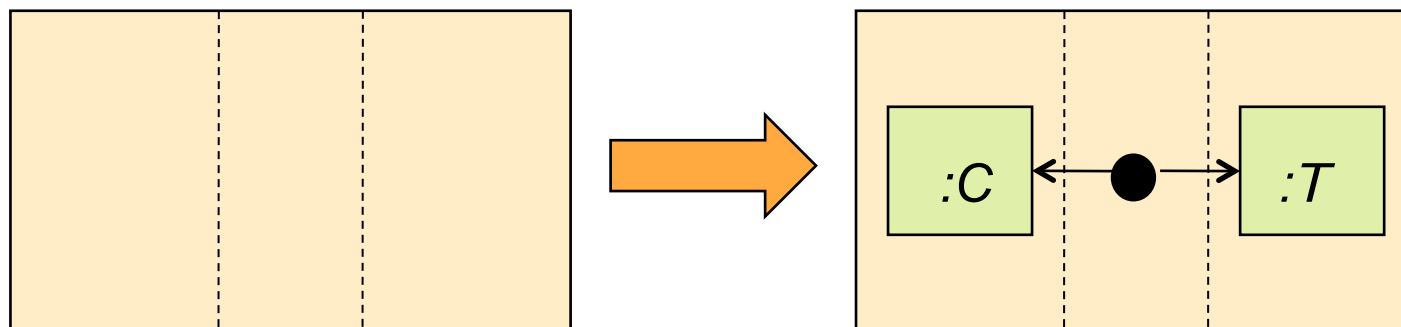

*class-table creation*

## *Transformation rules*

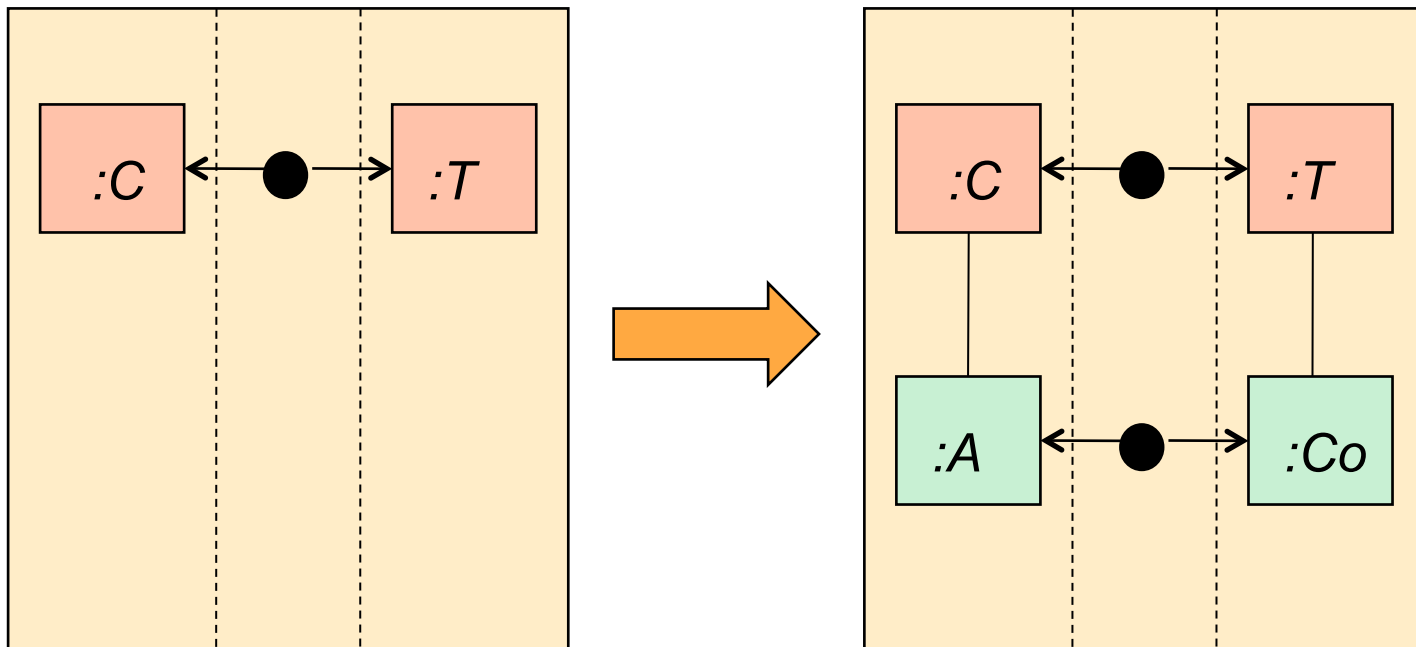

*attribute-column creation*

## *Transformation rules*

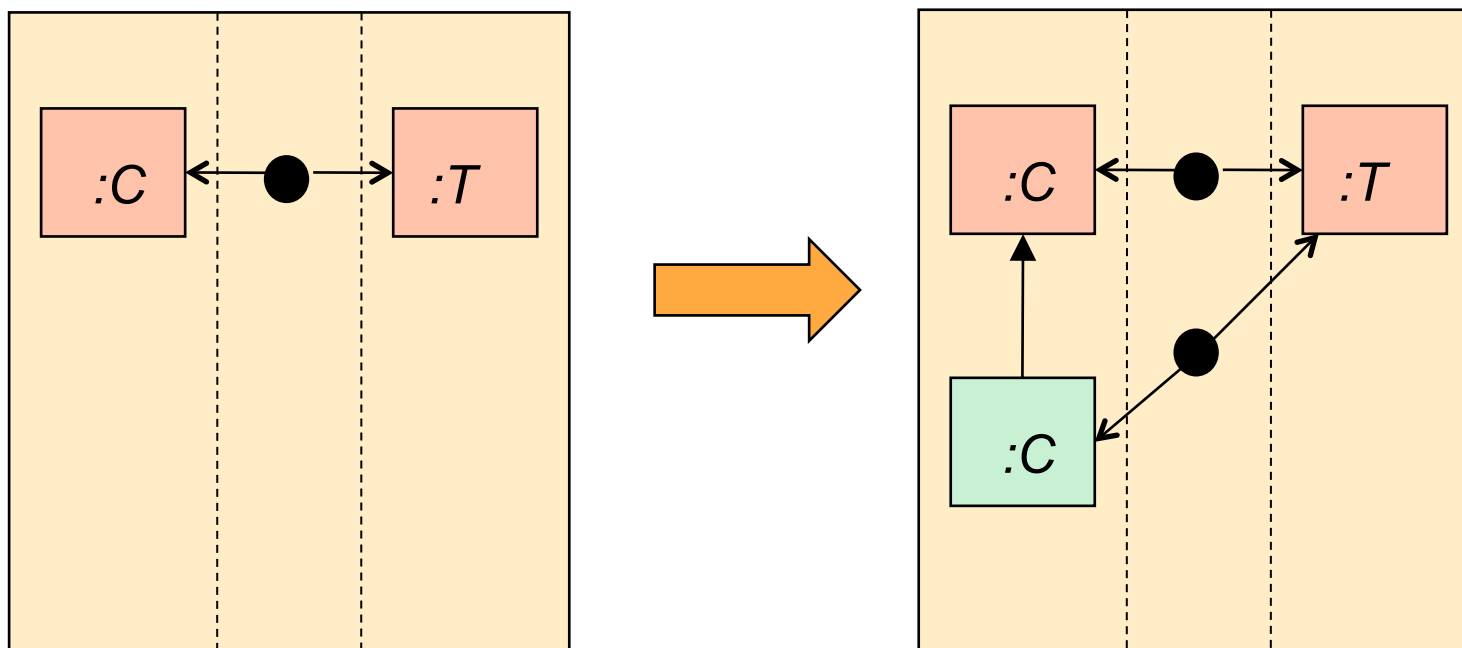

*Subclass creation*

## *Transformation rules*

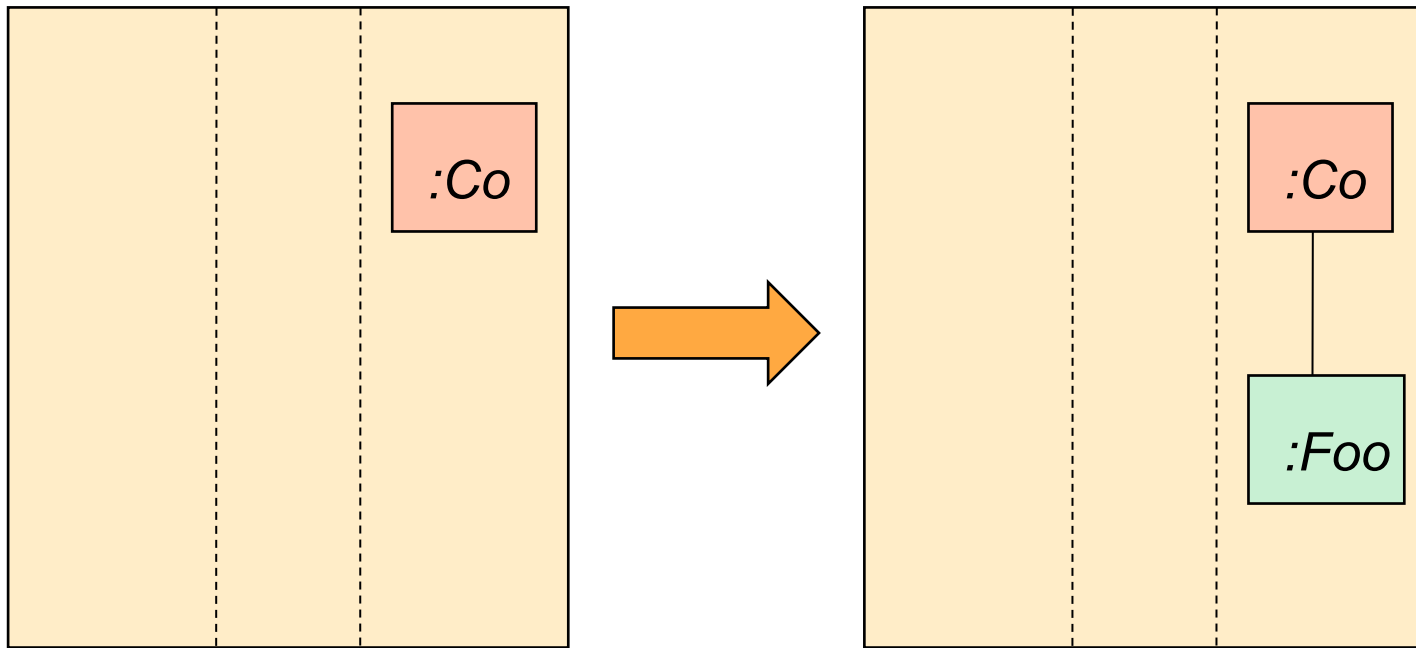

*Foo creation*

## *Transformation rules*

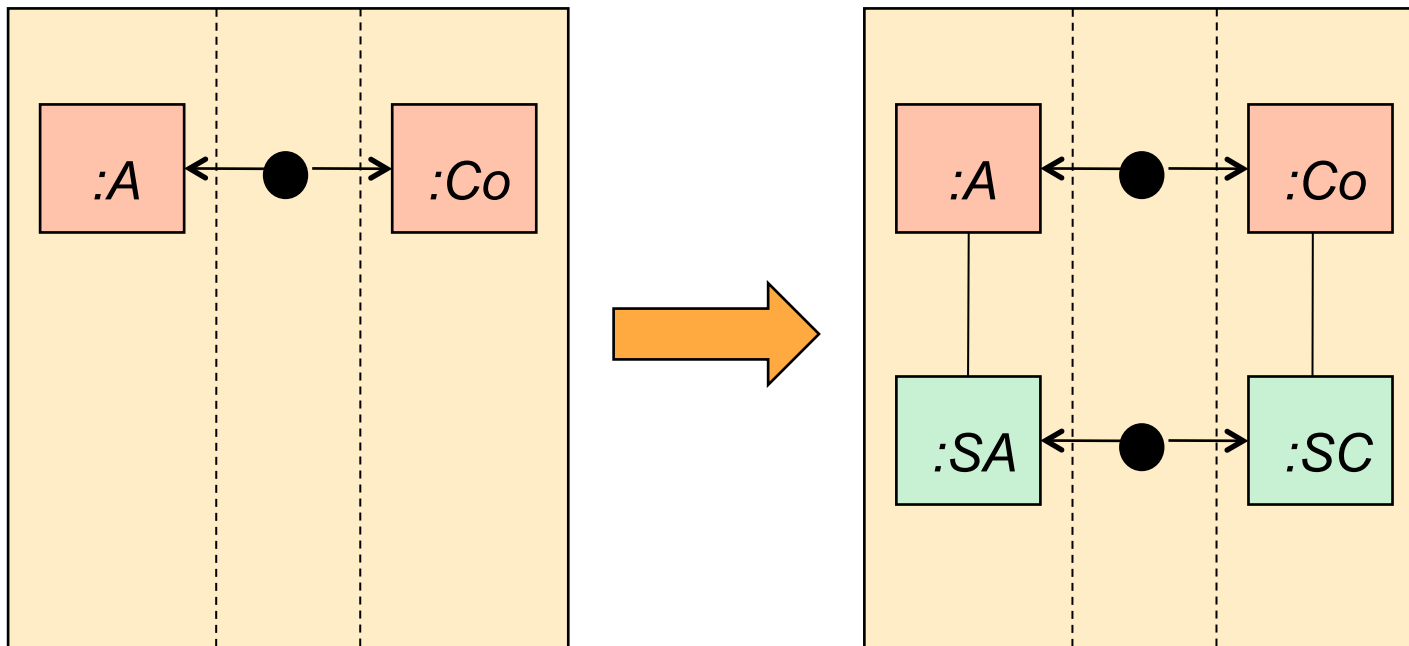

*subattribute - subcolumn creation*

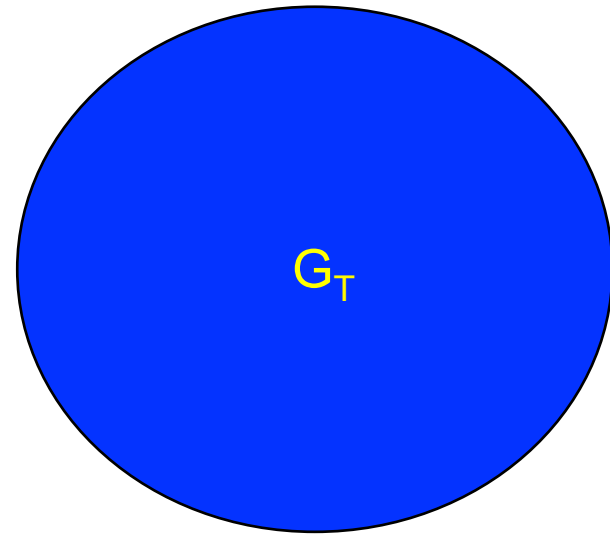
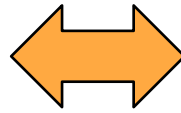

$\emptyset \leftrightarrow \emptyset \implies \dots \implies G_S \leftrightarrow G_T$

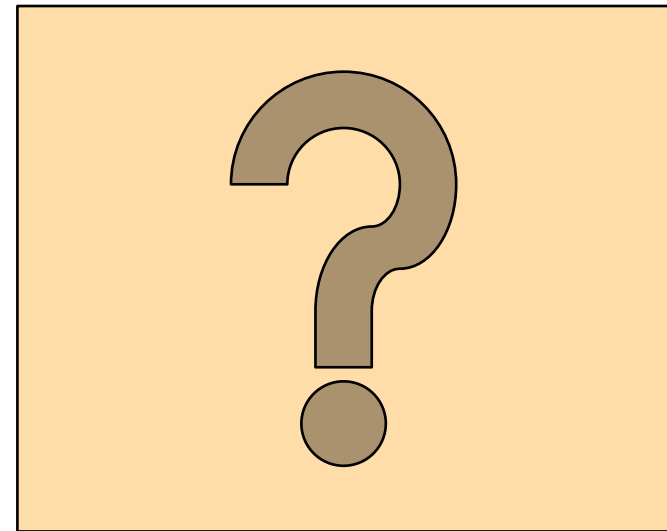
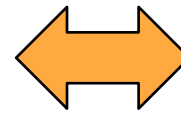
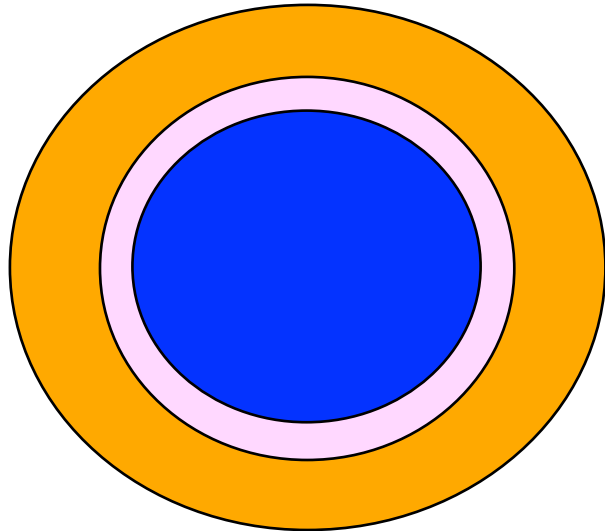
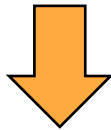

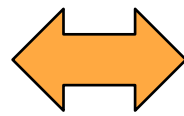
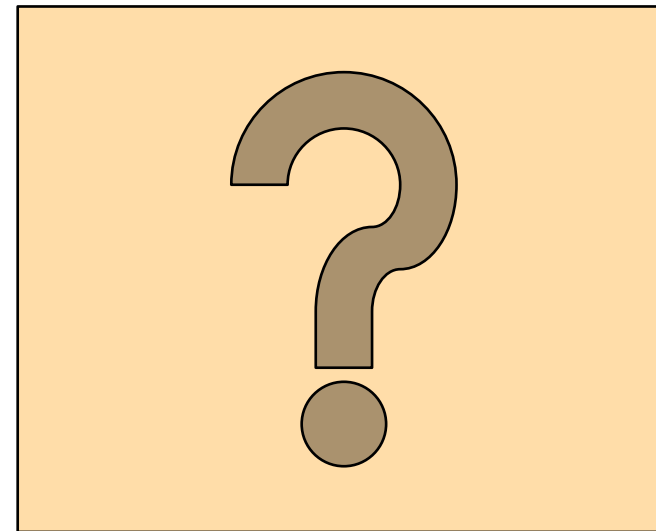
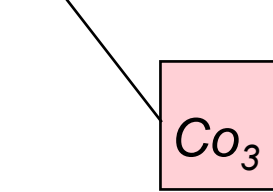
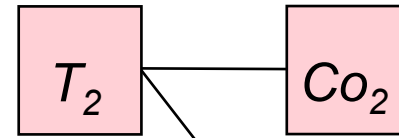
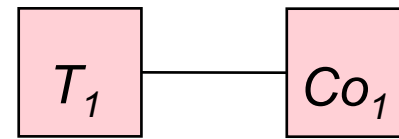
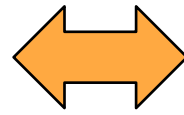
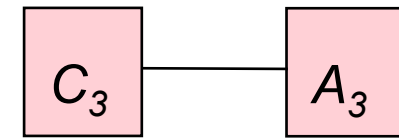
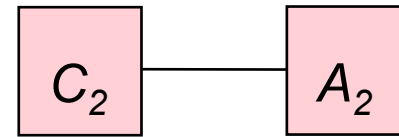
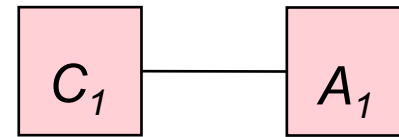
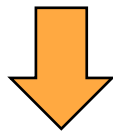
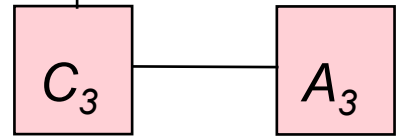
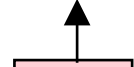
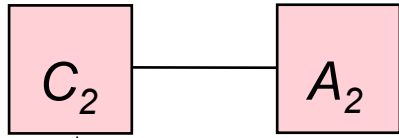
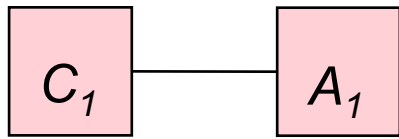

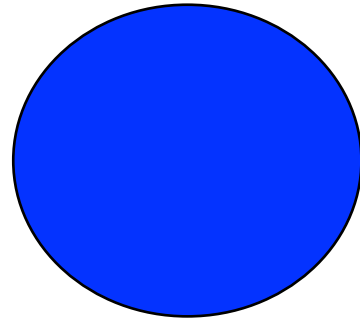
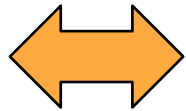
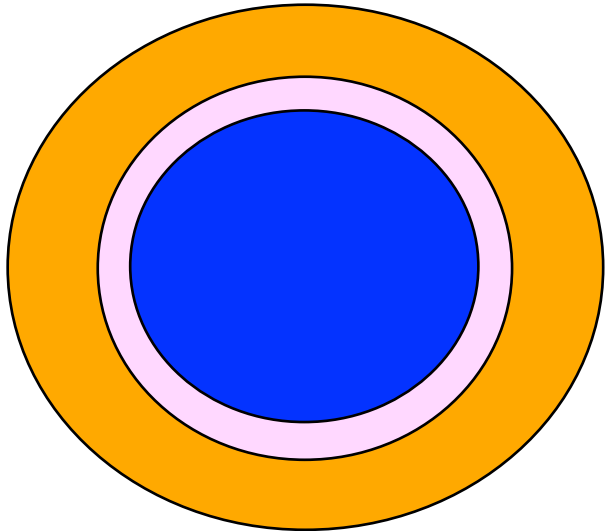
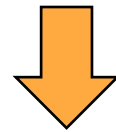
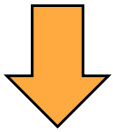
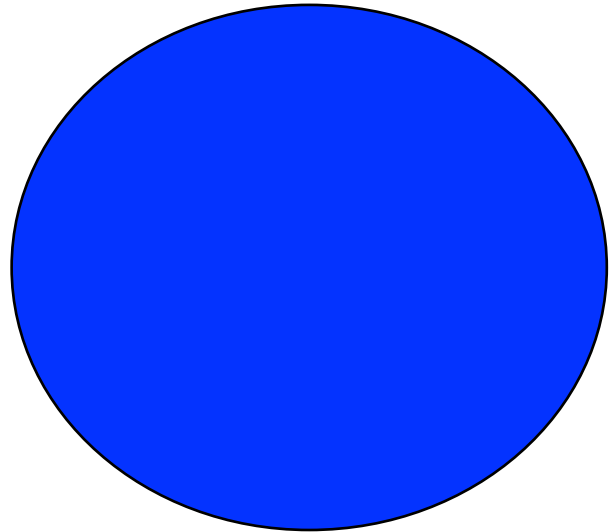
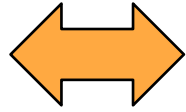
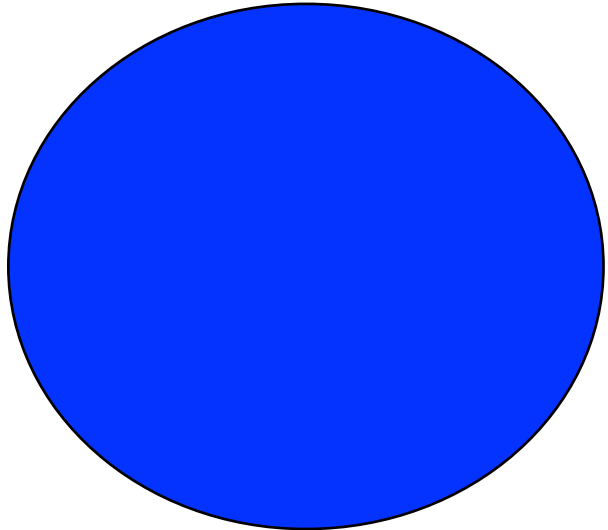



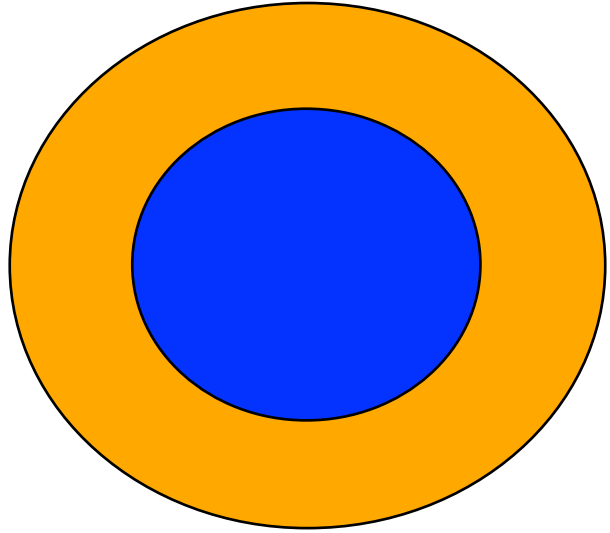
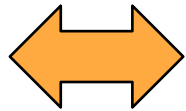
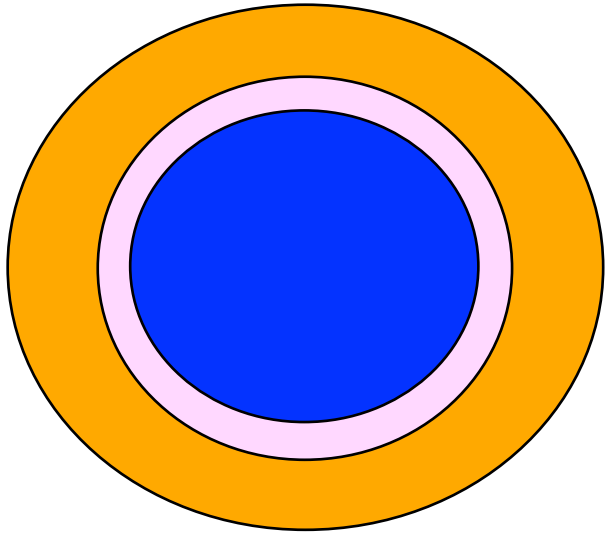
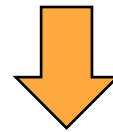
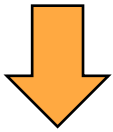
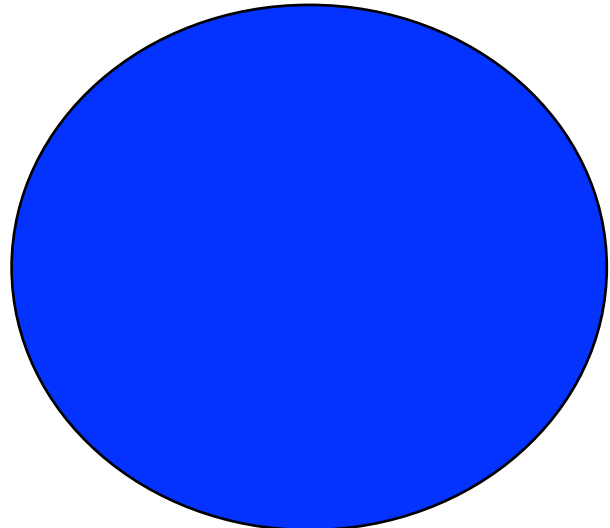
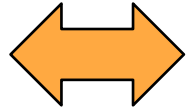
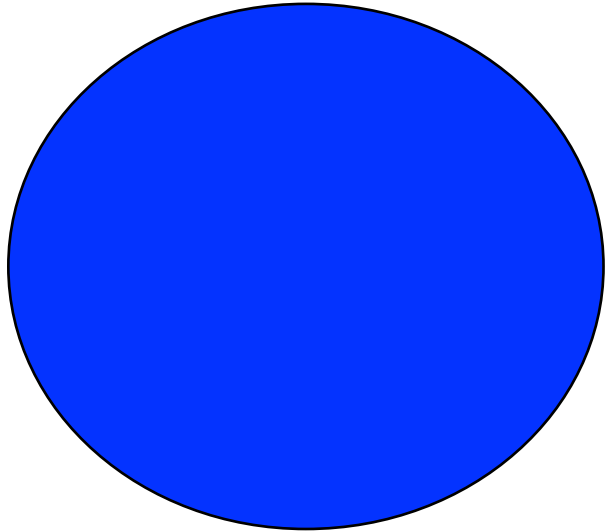

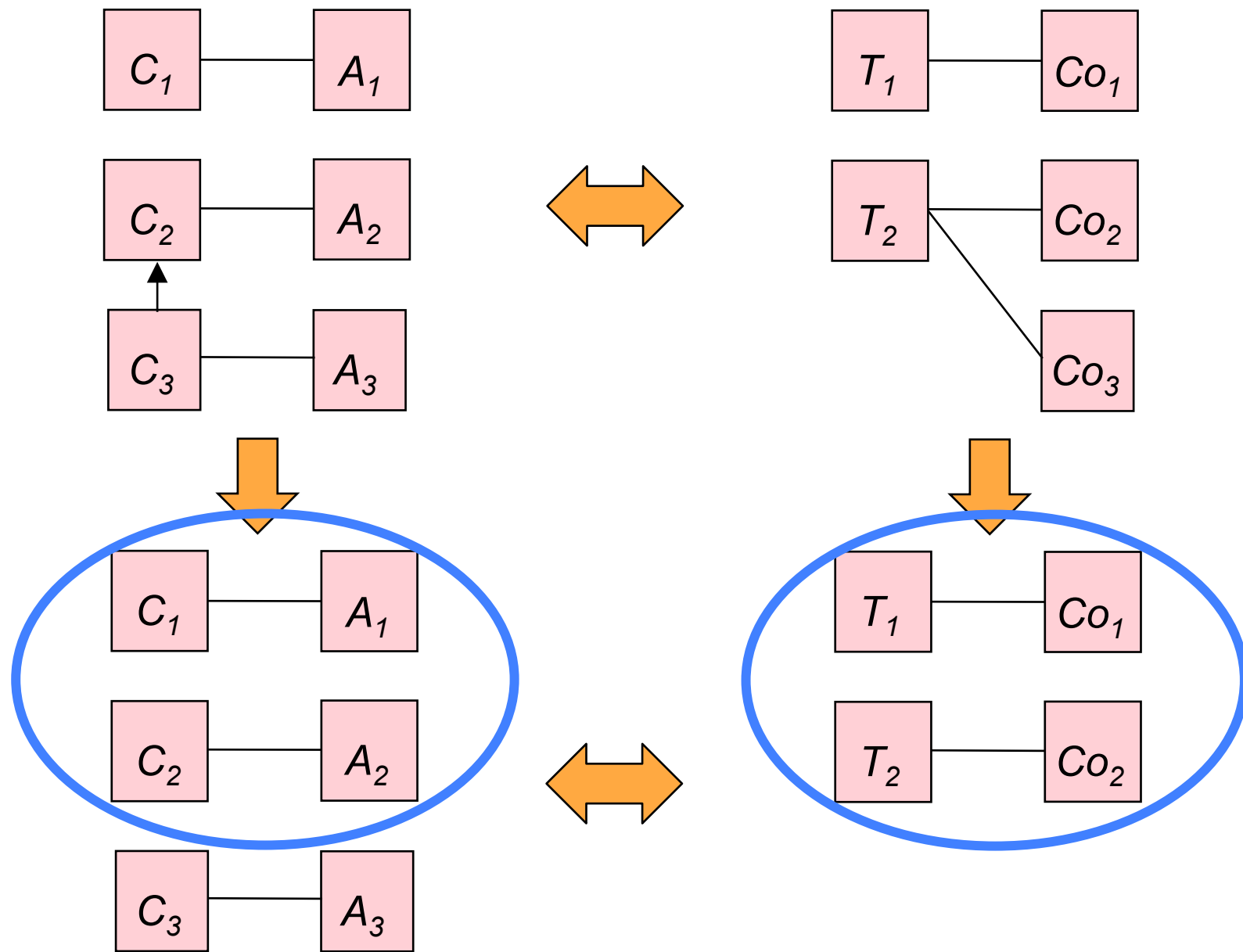

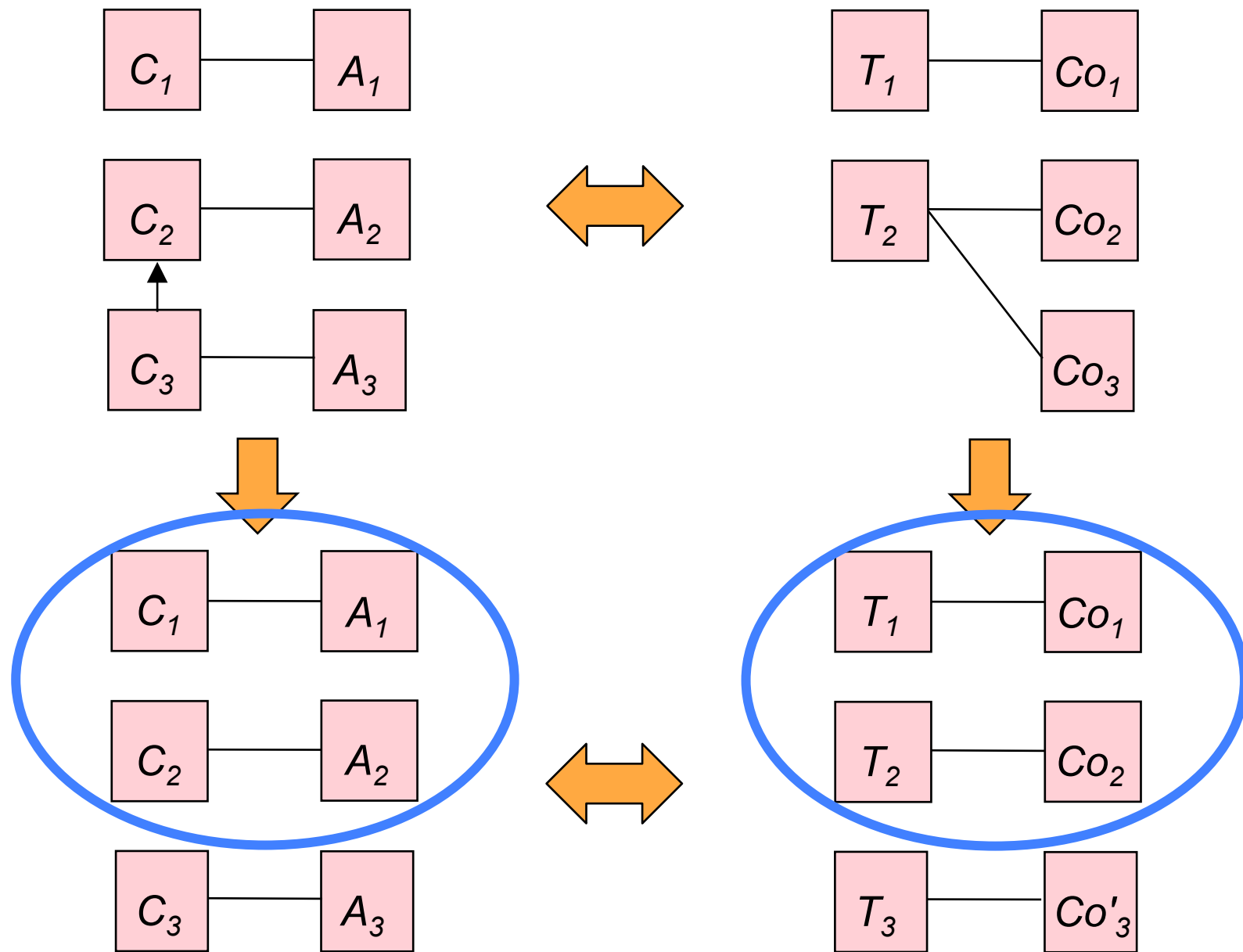

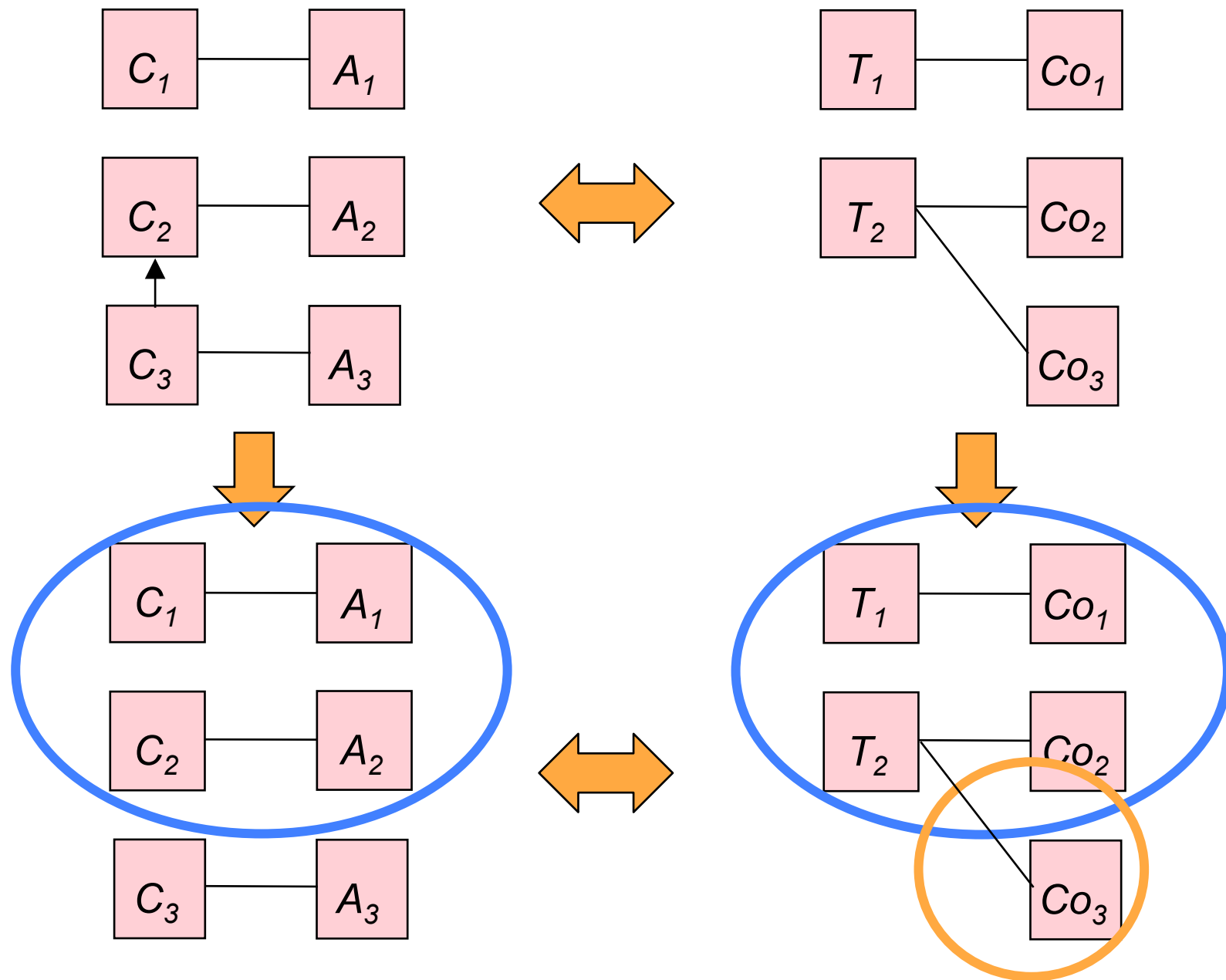

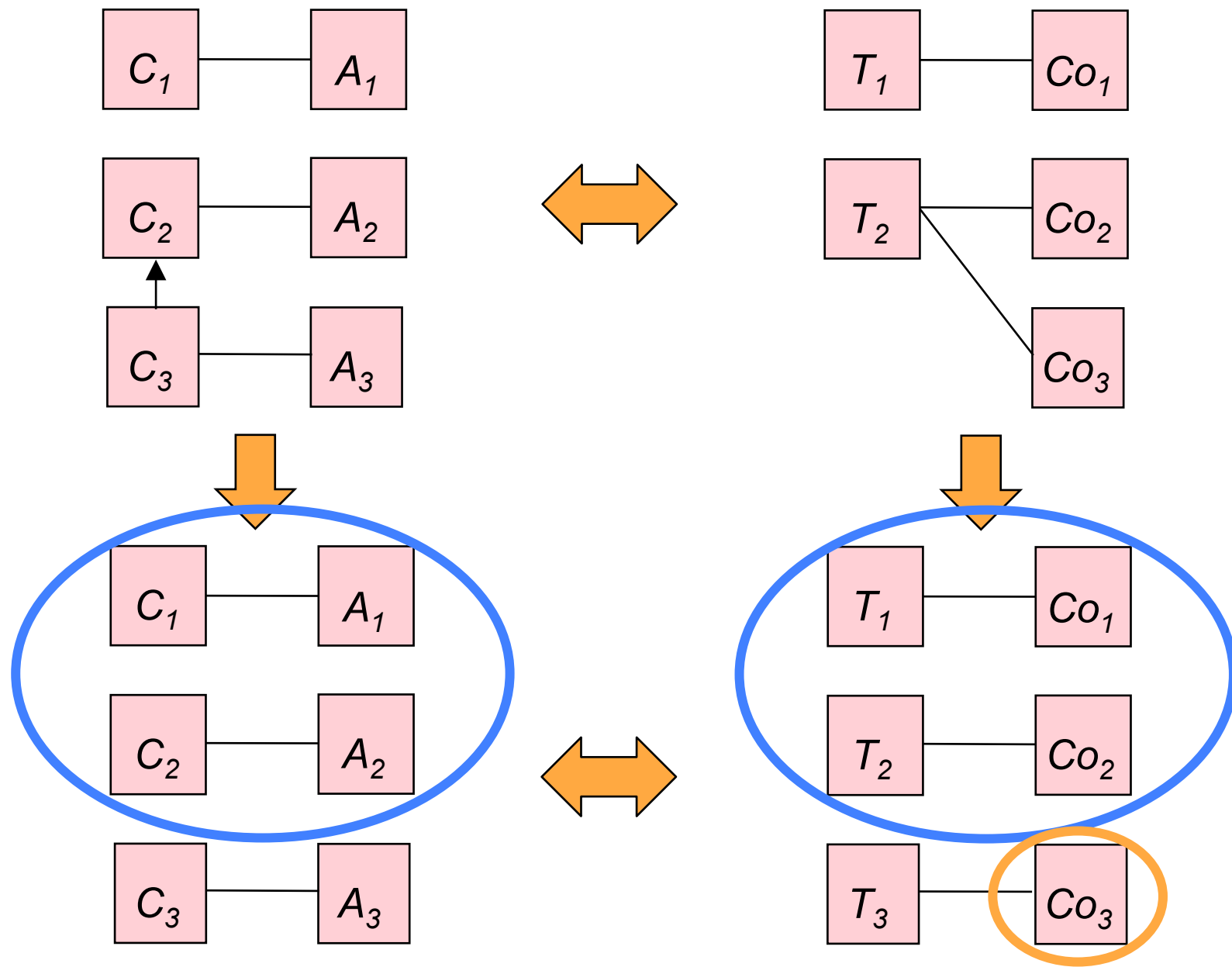

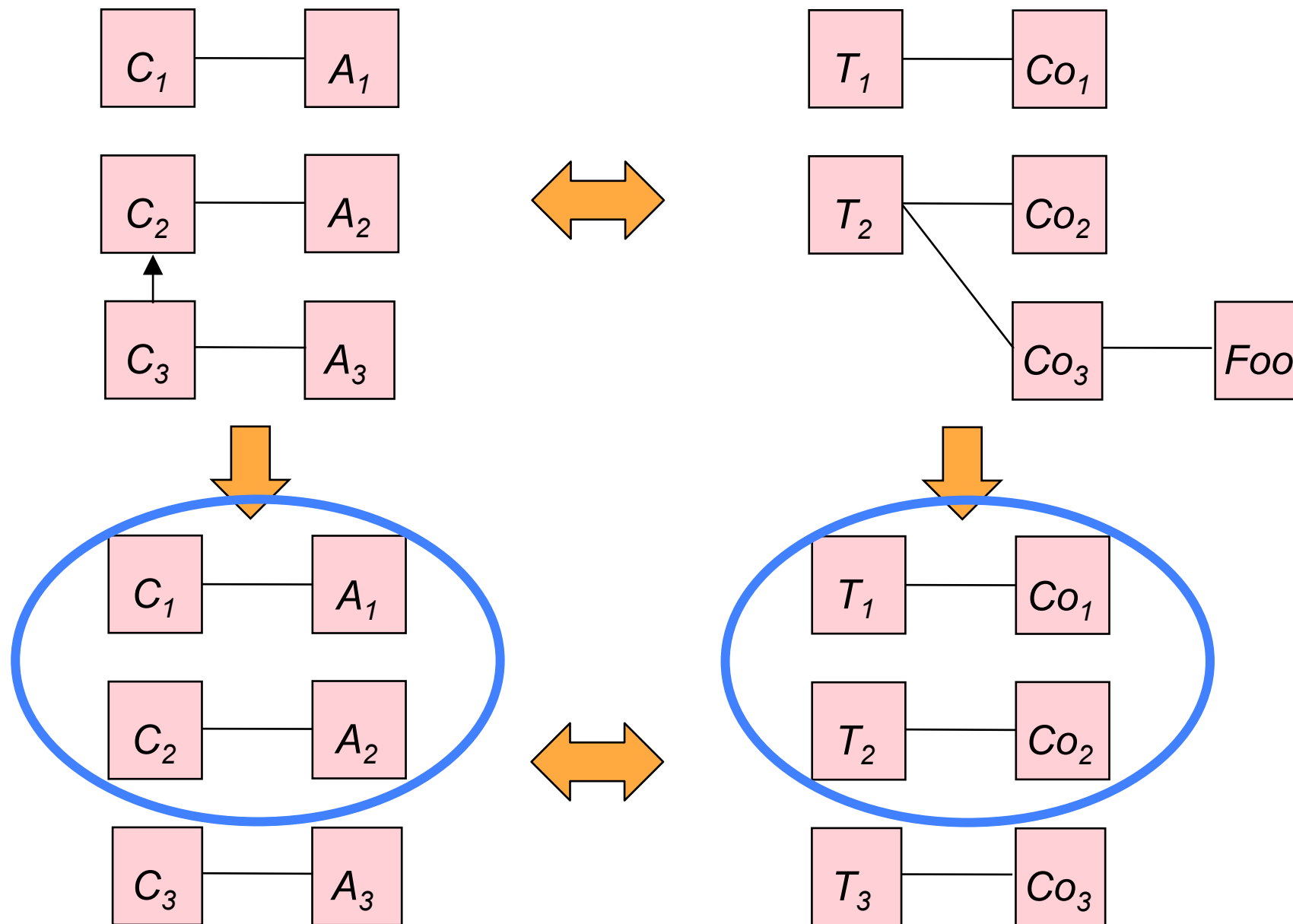

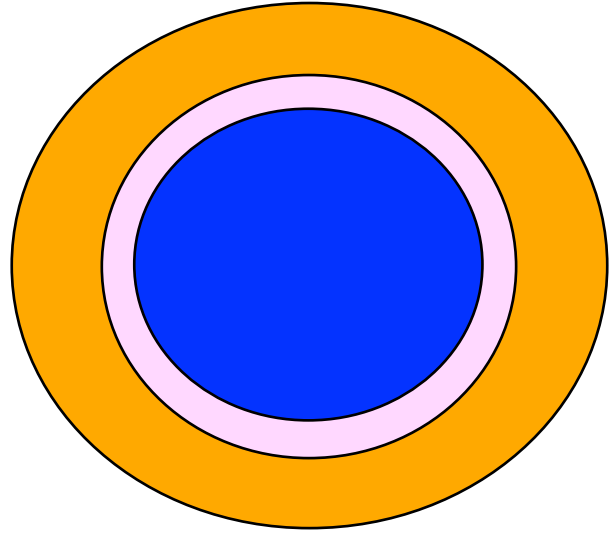
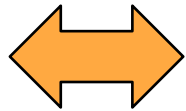
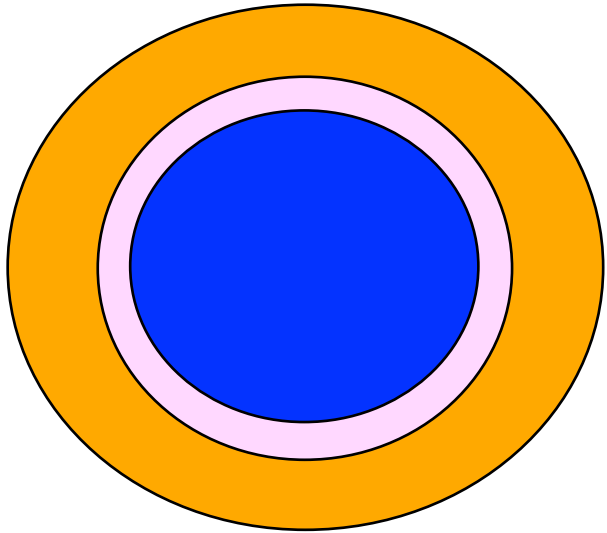
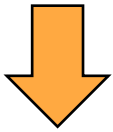
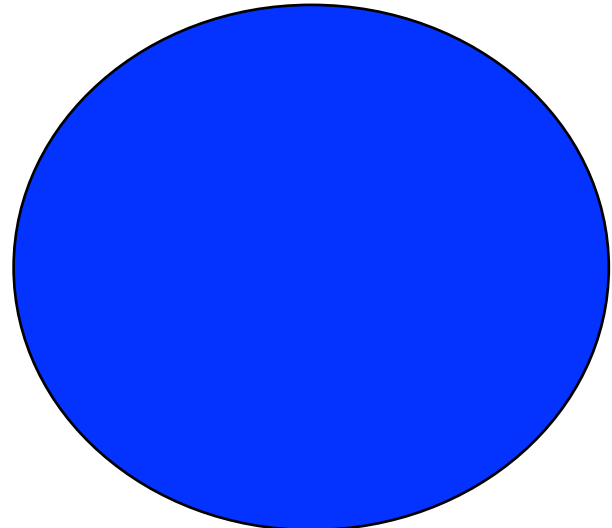
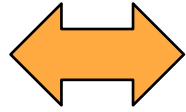
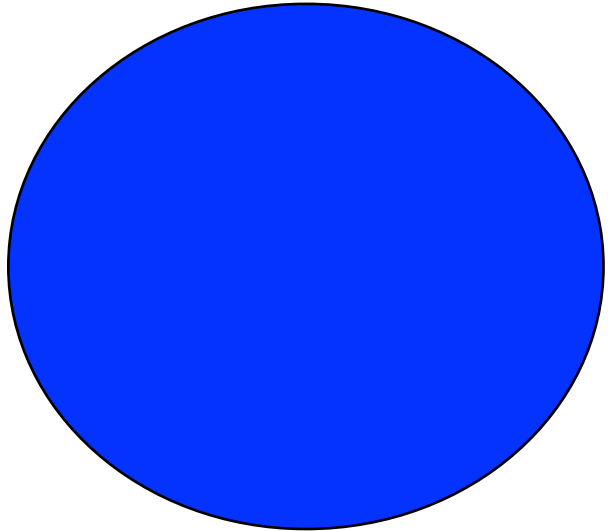

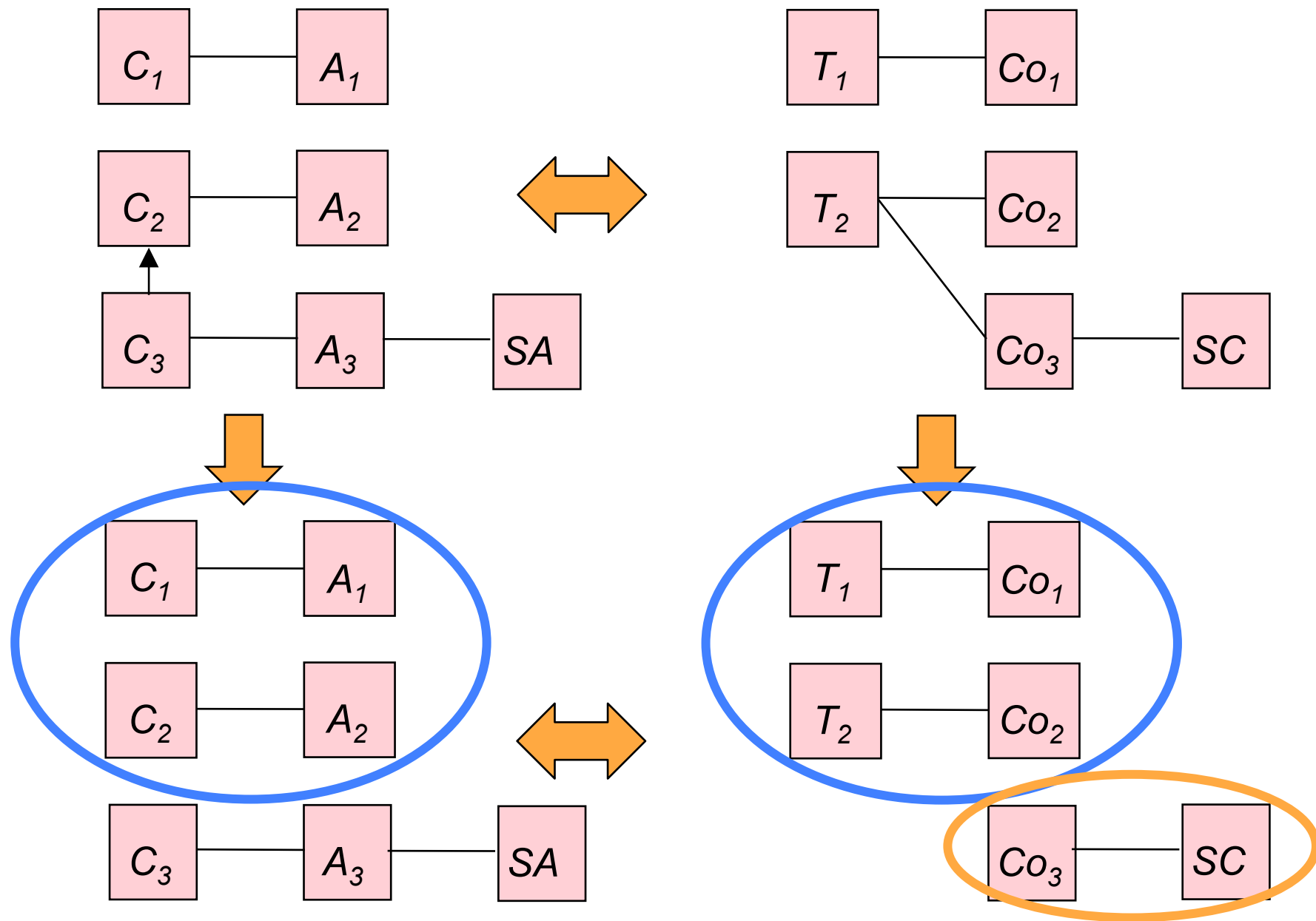



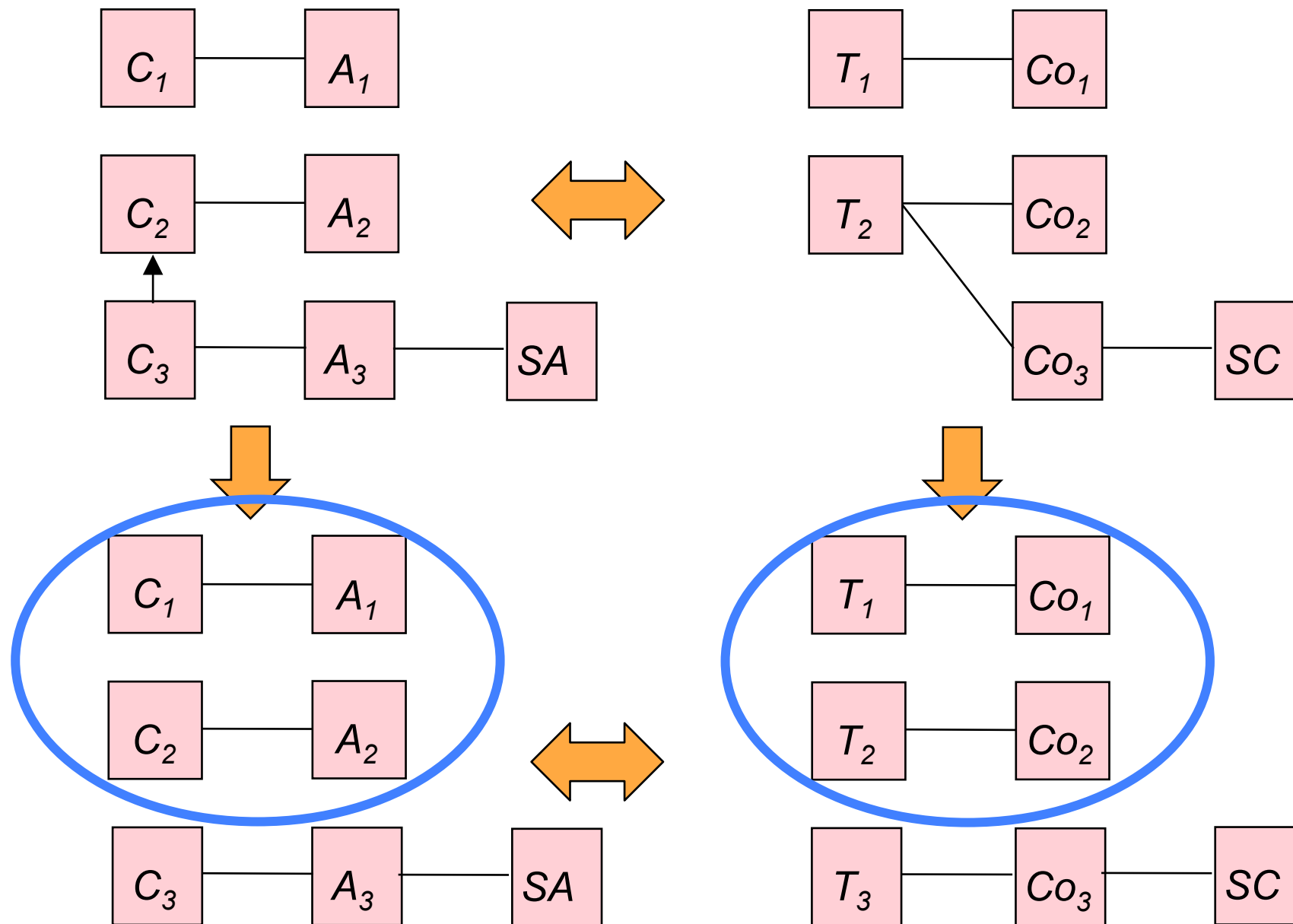

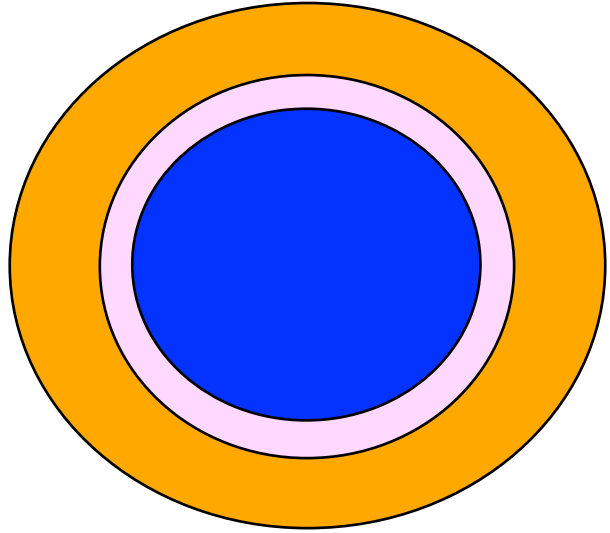
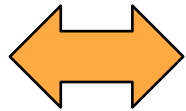
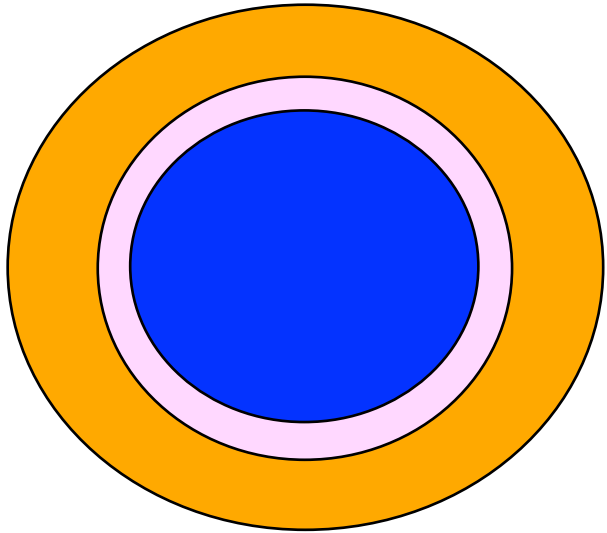
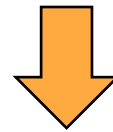
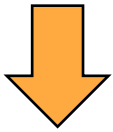
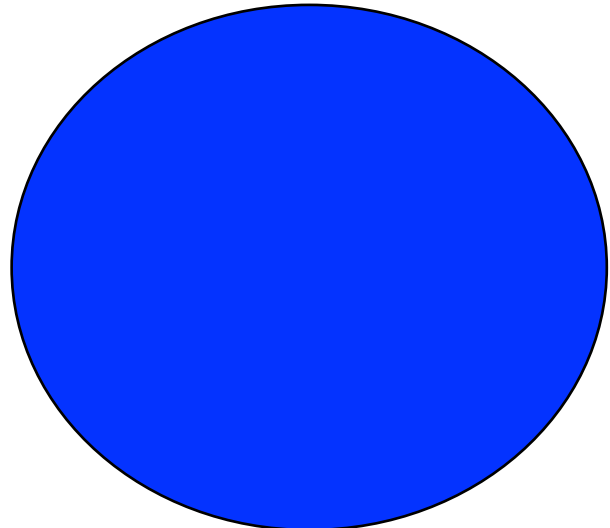
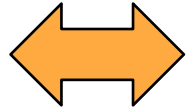
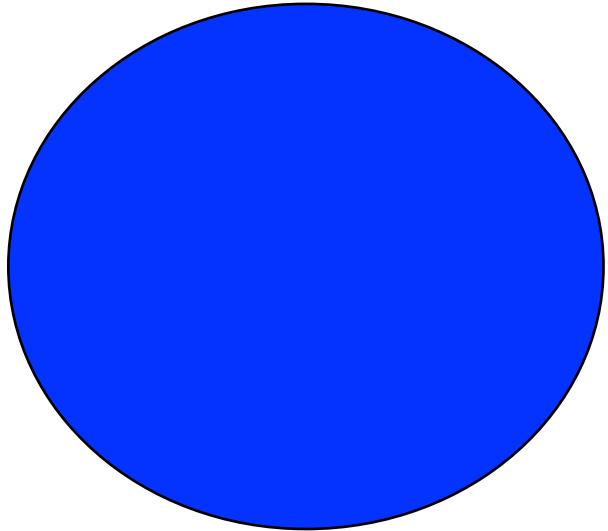

## *Conclusion*

- Incrementality may refer to how much we reuse from the given target model or to the performance of the synchronization procedure
- In any case, we have different degrees of incrementality.